

# OHMM<sup>®</sup>

COLLECTIONS 2023







## *Welcome to OHMM*

*We are here to help you create inspirational outdoor spaces to enjoy memorable relaxing times under the open skies.*

*Discover our world class quality outdoor furniture for both residential and hospitality.*

*Choose a collection you like and select your fibre and fabric colours to personalise it your way.*

*Lovingly handcrafted in our own factory in Cebu, home to the world's best woven craftsmen, using only the best in class materials.*

*All backed up with a worry free warranty.*

*Life is to be enjoyed.*

*Kevin Boland  
Founder*



# CONTENTS

## EXPLORE OHMM

BY COLLECTION 6 - 7

BY CATEGORY 8 - 11

## OHMM COLLECTIONS

BEACH 12 - 13

CABANA 14 - 15 **NEW**

CATALONIA 16 - 17 **NEW**

CLASSIC 18 - 21 **NEW ITEMS**

ECLIPSE 22 - 25

FIESTA 26 - 31

FLO 32 - 35

HORIZON 36 - 41 **NEW ITEMS**

HORIZON MINI 42 - 43 **NEW**

INTI 44 - 45

KEYWEST 46 - 51

KYOTO 52 - 53

LATITUDES 54 - 57

LINEAR 58 - 59

MANTRA 60 - 65

MAXIMUS 66 - 71 **NEW ITEMS**

MODULO 72 - 77

NOVO 78 - 81 **NEW ITEMS**

PALM 82 - 89 **NEW ITEMS**

PARTU 90 - 95 **NEW ITEMS**

SOL 96 - 101

SUMMER LIGHT 102 - 107

TAMARU 108 - 111

TRES 112 - 113

WAVE 114 - 115

ZEN 116 - 119 **NEW ITEMS**

## OHMM ACCESSORIES

PARASOLS 120 - 123

LANTERNS 124 - 127 **NEW**

PLANTERS 128 - 129

SIDE TABLES 130

FURNITURE COVERS 131 **NEW**

ACCENT CUSHIONS 132 - 133

## OHMM INFO SHEETS

PROJECTS 134 - 139

PERSONALISE &  
CUSTOMISE 140 - 141

FIBRE & POWDER  
COATINGS 142 - 145

CUSHIONS & FABRICS 146 - 147

TABLE TOPS 148

ICONS & OPTIONAL  
DESIGN FEATURES 149

HANDCRAFTED QUALITY 150 - 151

WHY WOVEN 152 - 153

LEARN MORE | CONTACT INFO 154

REASONS TO CHOOSE OHMM 155

WARRANTY 155

## ICONS & OPTIONAL DESIGN FEATURES



Custom  
Sizing

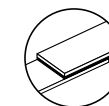

Optional  
Cushion Straps

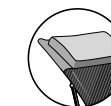

Optional Sun  
Lounger Headrests

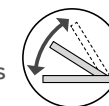

Adjustable  
Backrests

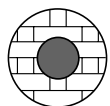

Optional  
Parasol Hole



Protective  
Footrests



Adjustable  
Gliders

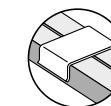

Modular  
Clips

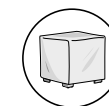

Optional  
Covers

# EXPLORE BY COLLECTION



**BEACH**  
12 - 13



**CABANA**  
14 - 15



**CATALONIA**  
16 - 17



**CLASSIC**  
18 - 21



**ECLIPSE**  
22 - 25



**FIESTA**  
26 - 31



**FLO**  
32 - 35



**HORIZON**  
36 - 41



**HORIZON MINI**  
42 - 43



**INTI**  
44 - 45



**KEYWEST**  
46 - 51



**KYOTO**  
52 - 53



**LATITUDES**  
54 - 57



**LINEAR**  
58 - 59



**MANTRA**  
60 - 65



**MAXIMUS**  
66 - 71



**MODULO**  
72 - 77



**NOVO**  
78 - 81



**PALM**  
82 - 89



**PARTU**  
90 - 95



**SOL**  
96 - 101



**SUMMER LIGHT**  
102 - 107



**TAMARU**  
108 - 111



**TRES**  
112 - 113



**WAVE**  
114 - 115



**ZEN**  
116 - 119



**PARASOLS**  
120 - 123



**LANTERNS**  
124 - 127



**PLANTERS**  
128 - 129



**SIDE TABLES**  
130



**FURNITURE COVERS**  
131



**ACCENT CUSHIONS**  
132 - 133



# EXPLORE BY CATEGORY

## CHAIRS



BEACH 12



CATALONIA 16



CLASSIC 18



FIESTA 26



FLO 32



HORIZON 36



KEYWEST 46



LATITUDES 54



MAXIMUS 66



NOVO 78



PALM 82



ZEN 116

## TABLES | DINING | BISTRO



BEACH 12



CATALONIA 16



FIESTA 26



FLO 32



HORIZON 36



KEYWEST 46



KYOTO 53



LATITUDES 54



LINEAR 58



MAXIMUS 66



PALM 82



PARTU 90



TRES 112

## DAY BEDS



CABANA 15



HORIZON 38



SOL 96



TAMARU 109

## LOUNGE



FLO 33



HORIZON 37



HORIZON MINI 42



KEYWEST 47



LATITUDES 55



MANTRA 60



MAXIMUS 67



MODULO 72



PALM 83



SOL 96



SUMMER LIGHT 102

## LOUNGE MODULAR



HORIZON 36



HORIZON MINI 42



MANTRA 60



MAXIMUS 66



MODULO 72



PALM 82



SUMMER LIGHT 102



# EXPLORE BY CATEGORY

## CHAISES LONGUES



HORIZON 38



MANTRA 61



MAXIMUS 68



MODULO 73



PALM 84



SUMMER LIGHT 103

## SUN LOUNGERS



CLASSIC 18



ECLIPSE 23



FIESTA 27



FLO 33



HORIZON 38



INTI 45



KEYWEST 47



MAXIMUS 68



MODULO 74



NOVO 78



PALM 84



WAVE 115



ZEN 117

## BAR



FLO 33



PALM 84



PARTU 91



ZEN 117

## BENCHES | STOOLS | OTTOMANS | FOOT STOOLS



FLO 33



HORIZON 38



HORIZON MINI 43



KYOTO 52



LATITUDES 55



LINEAR 58



MANTRA 61



MAXIMUS 67



MODULO 73



PALM 83



SOL 96



SUMMER LIGHT 103



ZEN 117

## TABLES | COFFEE | SIDE



FIESTA 26



FLO 33



HORIZON 38



HORIZON MINI 43



KEYWEST 47



LATITUDES 55



MANTRA 62



MAXIMUS 68



MODULO 74



PALM 84



PARTU 91



SOL 97



SUMMER LIGHT 104



ZEN 117

## ACCESSORIES



PARASOLS 120



LANTERNS 124



PLANTERS 128



SIDE TABLES 130



FURNITURE COVERS 131



ACCENT CUSHIONS 132



# BEACH

DESIGNED BY  
OHMM® Design Studio

CHARACTERISTICS  
Lightweight | Airy | Casual



## RECOMMENDED FINISHING PAIRINGS



## Arm Chair

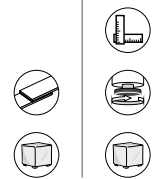
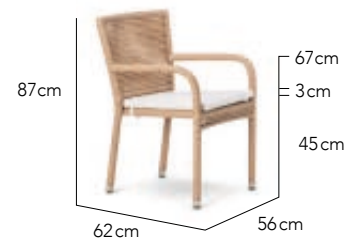

## Bistro Table



 MORE FIBRE OPTIONS | 142 - 143

 MORE FABRIC OPTIONS | 146 - 147

 ACCENT CUSHION OPTIONS | 132 - 133

 OTHER TABLE SIZES AVAILABLE IN 80 | 90 | 100 CM Ø

## TABLE TOP OPTIONS | 148



FIBRE  
FULLY WOVEN



FIBRE &  
CLEAR GLASS







# CABANA NEW

DESIGNED BY  
OHMM® Design Studio

CHARACTERISTICS  
Rectilinear | Sturdy | Comfortable



## RECOMMENDED FINISHING PAIRINGS

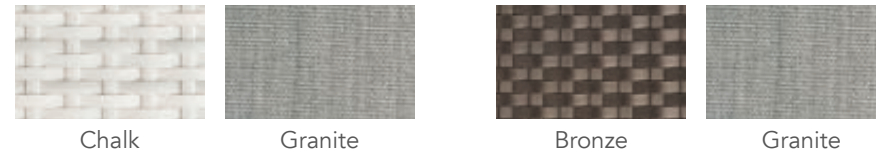



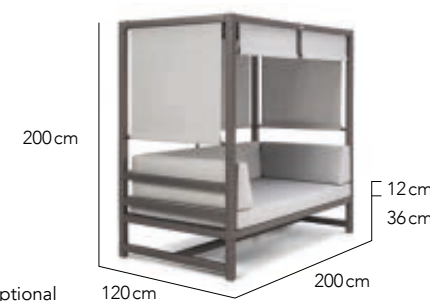

### Day Bed

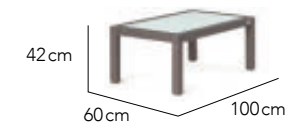

Side Canopies Optional

### Coffee Table



-  MORE FIBRE OPTIONS | 142
-  MORE FABRIC OPTIONS | 146 - 147
-  ACCENT CUSHION OPTIONS | 132 - 133

## TABLE TOP OPTIONS | 148





# CATALONIA NEW

DESIGNED BY  
Kevin Boland

CHARACTERISTICS  
Sculptured | Ergonomic | Dynamic



RECOMMENDED FINISHING PAIRINGS



Side Chair



Arm Chair



Dining Table



Dining Table

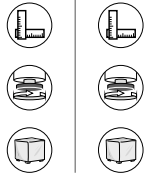

Dining Table



- MORE FIBRE OPTIONS | 142
- MORE FABRIC OPTIONS | 146 - 147

TABLE TOP OPTIONS | 148





# CLASSIC

DESIGNED BY  
OHMM® Design Studio

CHARACTERISTICS  
Timeless | Versatile | Elegant



## RECOMMENDED FINISHING PAIRINGS



Side Chair

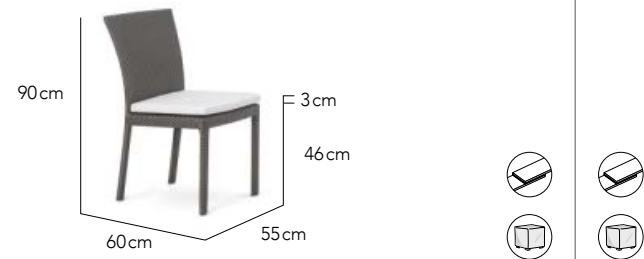

Arm Chair

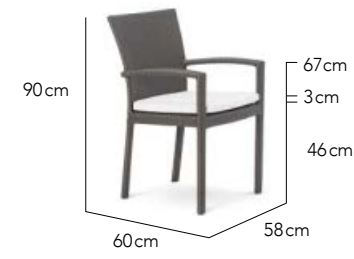

Side Table



2 Seater Arm Chair

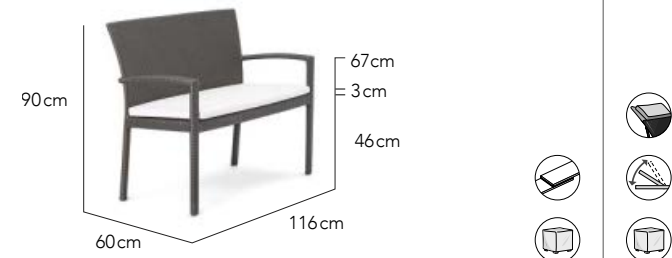

Sun Lounger



 MORE FIBRE OPTIONS | 142

 COMBINES WELL WITH PARTU TABLES | 90 - 95

 MORE FABRIC OPTIONS | 146 - 147

 ACCENT CUSHION OPTIONS | 132 - 133

 OPTIONAL SUN LOUNGER HEADRESTS | 149









# ECLIPSE

DESIGNED BY  
OHMM® Design Studio

CHARACTERISTICS  
Curvaceous | Elegant | Graceful



## RECOMMENDED FINISHING PAIRINGS

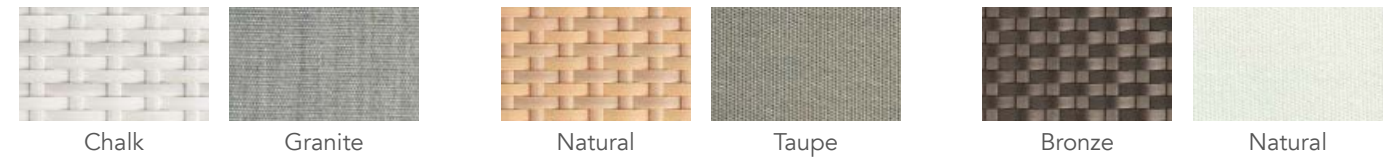

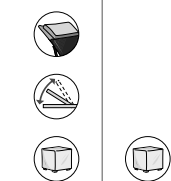

## Sun Lounger



## Side Table



-  MORE FIBRE OPTIONS | 142
-  MORE FABRIC OPTIONS | 146 - 147
-  OPTIONAL SUN LOUNGER HEADRESTS | 149

HIGHER SEAT VERSION AND DOUBLE SUN LOUNGER VERSION ALSO AVAILABLE

[BACK TO TABLE OF CONTENTS](#)







# FIESTA

DESIGNED BY  
OHMM® Design Studio

CHARACTERISTICS  
Stylish | Curvaceous | Contemporary Classic



## RECOMMENDED FINISHING PAIRINGS



Arm Chair

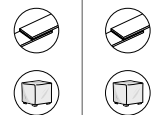

2 Seater Arm Chair



Side Table



Bistro Table



Dining Table

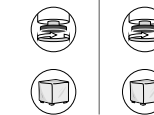

Dining Table



Sun Lounger

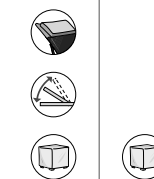

Sun Lounger Side Table



MORE FIBRE OPTIONS | 143

MORE FABRIC OPTIONS | 146 - 147

ACCENT CUSHION OPTIONS | 132 - 133

OPTIONAL SUN LOUNGER HEADRESTS | 149

TABLE TOP OPTIONS | 148



FIBRE FULLY WOVEN



FIBRE & CLEAR GLASS







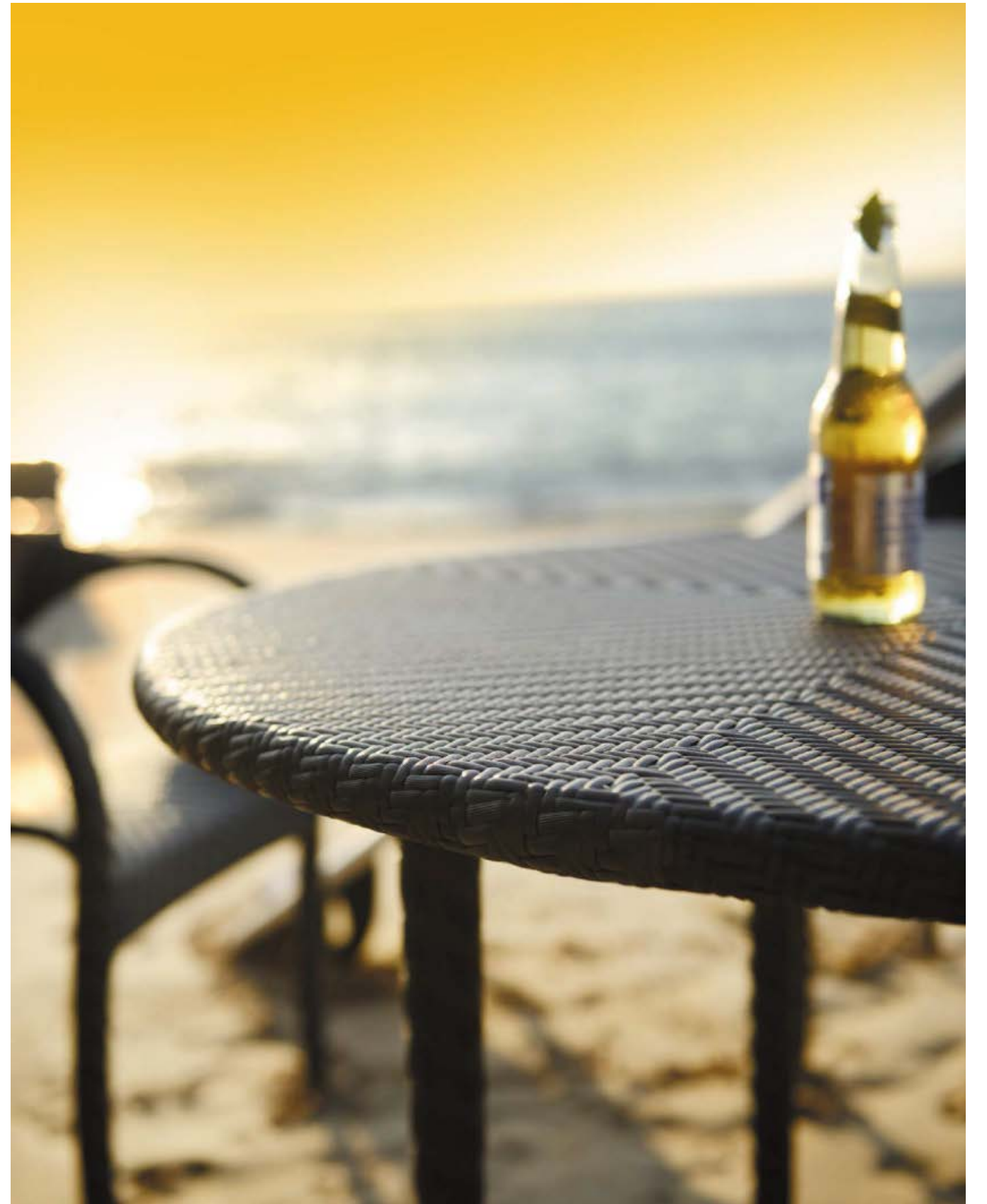



# FLO

DESIGNED BY  
Kevin Boland

CHARACTERISTICS  
Relaxed | Light | Smart



## RECOMMENDED FINISHING PAIRINGS

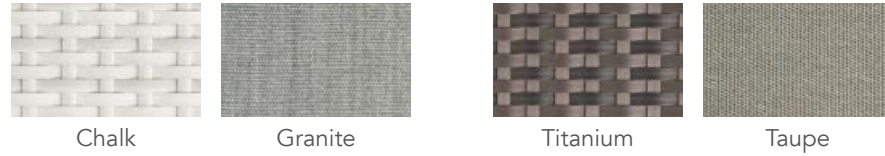

## Side Chair

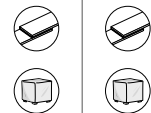

## Arm Chair

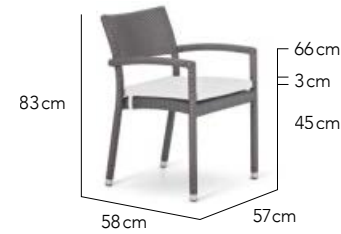

## Club Chair

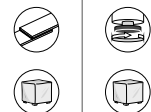

## Bistro Table



## Lounge Chair



## 2 Seater Sofa



## 3 Seater Sofa



## Foot Stool



## Coffee Table

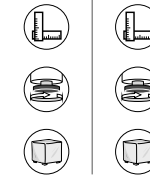

## Coffee Table



## Side Table

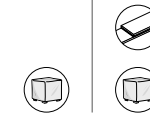
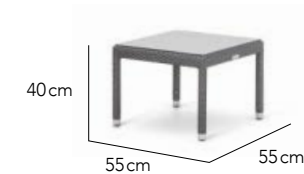

## Bar Chair



## Sun Lounger

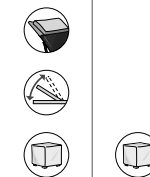

## Sun Lounger Side Table

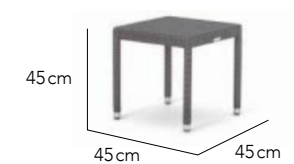

MORE FIBRE OPTIONS | 142 - 143

MORE FABRIC OPTIONS | 146 - 147

ACCENT CUSHION OPTIONS | 132 - 133

COMBINES WELL WITH PARTU TABLES | 90 - 95

## TABLE TOP OPTIONS | 148



FIBRE  
FULLY WOVEN



FIBRE &  
CLEAR GLASS







# HORIZON

## NEW MODULAR ELEMENTS

DESIGNED BY  
Kevin Boland

CHARACTERISTICS  
Slim | Elegant | Minimal



### RECOMMENDED FINISHING PAIRINGS



### Arm Chair

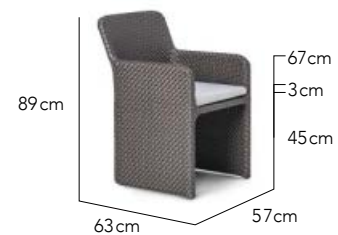

NEW

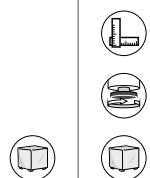

### Dining Table



### Dining Table

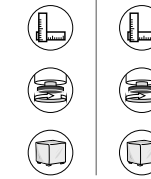

### Dining Table



### Lounge Chair

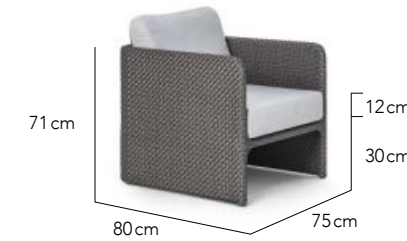

### 2 Seater Sofa



### 3 Seater Sofa

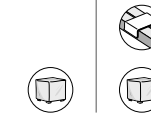

### Corner Module



NEW

### Left Module S



NEW

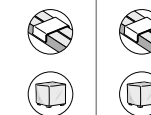

### Right Module S

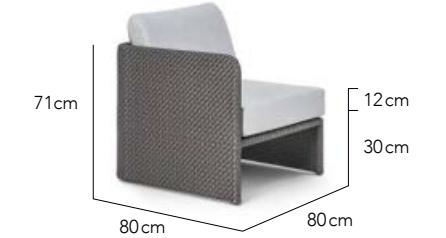

NEW

### Left Module L



NEW

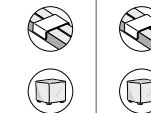

### Right Module L



NEW

### Centre Module S



NEW

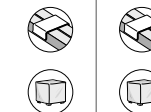

### Centre Module L



NEW



Backless Module S / Ottoman

NEW

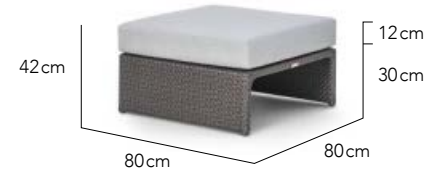

Chaise Longue L

NEW



Chaise Longue R

NEW



Chaise Longue Double

NEW



Day Bed S



Day Bed L



Side Table

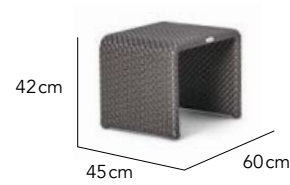

Coffee Table

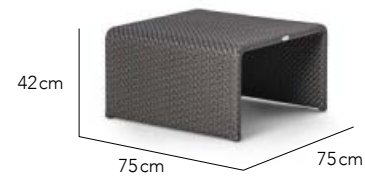

Coffee Table



Sun Lounger (Cushion Optional)



Sun Lounger Side Table

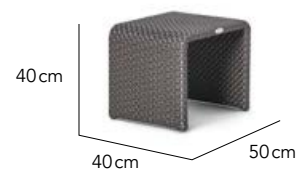

MORE FIBRE OPTIONS | 143

MORE FABRIC OPTIONS | 146 - 147

ACCENT CUSHION OPTIONS | 132 - 133

OPTIONAL SUN LOUNGER HEADRESTS | 149

TABLE TOP OPTIONS | 148



FIBRE FULLY WOVEN



FIBRE & CLEAR GLASS



FROSTED GLASS INSERT







# HORIZON MINI NEW

DESIGNED BY  
Kevin Boland

CHARACTERISTICS  
Slim | Elegant | Minimal



## RECOMMENDED FINISHING PAIRINGS



Lounge Chair

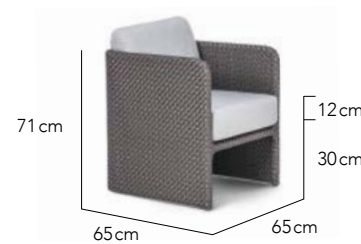

2 Seater Sofa



3 Seater Sofa

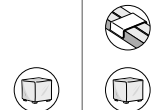

Corner Module



Left Module S

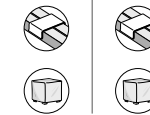

Right Module S

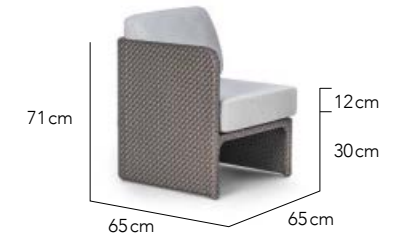

Left Module L

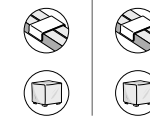

Right Module L



Centre Module S

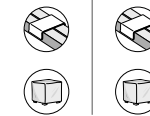

Centre Module L



Backless Module S /  
Ottoman

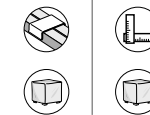
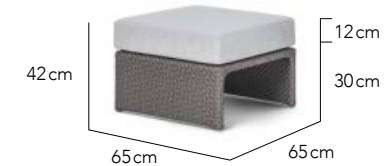

Side Table

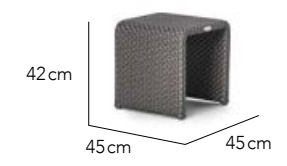

Coffee Table

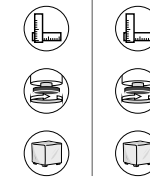
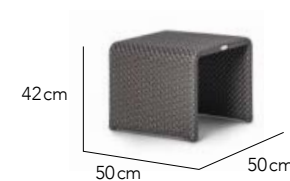

Coffee Table

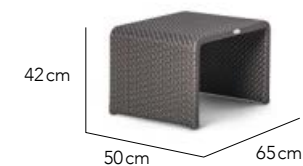

 MORE FIBRE OPTIONS | 143

 MORE FABRIC OPTIONS | 146 - 147

 ACCENT CUSHION OPTIONS | 132 - 133





# INTI

DESIGNED BY  
Kevin Boland

CHARACTERISTICS  
Angular | Robust | Distinctive



## RECOMMENDED FINISHING PAIRINGS



Chalk



Granite



Natural



Natural

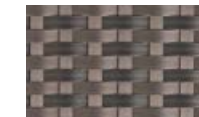

Titanium



Granite

## Sun Lounger

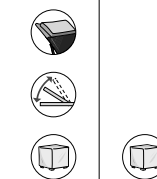

## Side Table



 MORE FIBRE OPTIONS | 142

 MORE FABRIC OPTIONS | 146 - 147

 OPTIONAL SUN LOUNGER HEADRESTS | 149



# KEYWEST

DESIGNED BY  
Kevin Boland

CHARACTERISTICS  
Traditionally Modern | Stylish | Versatile



## RECOMMENDED FINISHING PAIRINGS

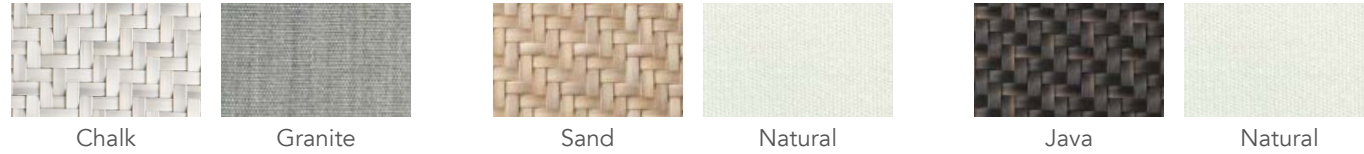

Arm Chair

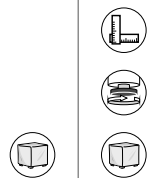
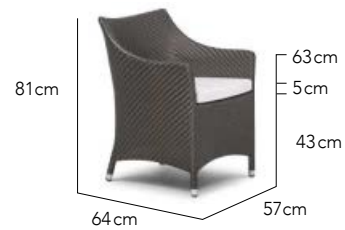

Dining Table



Dining Table

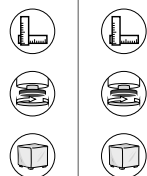

Dining Table



Dining Table

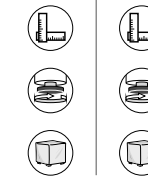

Dining Table



Lounge Chair



2 Seater Sofa



3 Seater Sofa

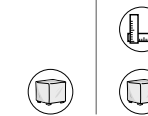

Side Table



Coffee Table

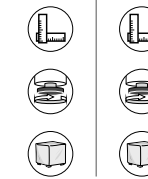

Coffee Table



Sun Lounger

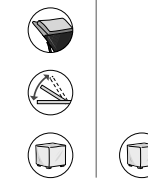
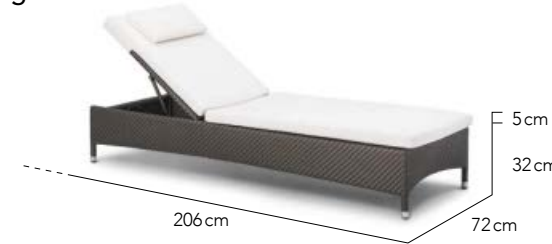

Sun Lounger Side Table



MORE FIBRE OPTIONS | 143

MORE FABRIC OPTIONS | 146 - 147

ACCENT CUSHION OPTIONS | 132 - 133

OPTIONAL SUN LOUNGER HEADRESTS | 149

TABLE TOP OPTIONS | 148



FIBRE  
FULLY WOVEN



FIBRE &  
CLEAR GLASS



FROSTED  
GLASS INSERT











# KYOTO

DESIGNED BY  
Kevin Boland

CHARACTERISTICS  
Compact | Versatile | Efficient



## RECOMMENDED FINISHING PAIRINGS

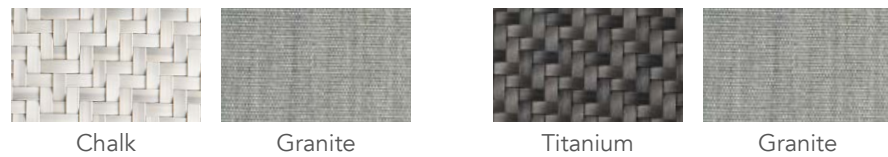

## Stool

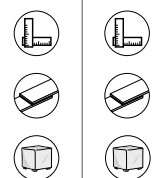
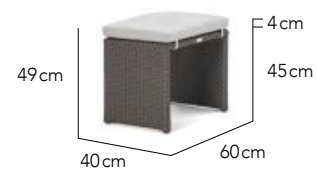

## Bench



## Table

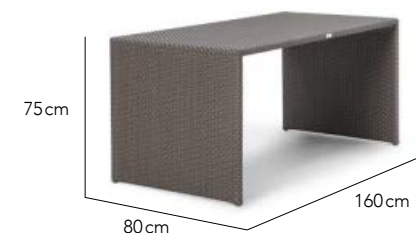

 MORE FIBRE OPTIONS | 143

 MORE FABRIC OPTIONS | 146 - 147

## TABLE TOP OPTIONS | 148



FIBRE  
FULLY WOVEN



FIBRE &  
CLEAR GLASS



# LATITUDES

DESIGNED BY  
Kevin Boland

CHARACTERISTICS  
Rectilinear | Sleek | Modern



## RECOMMENDED FINISHING PAIRINGS

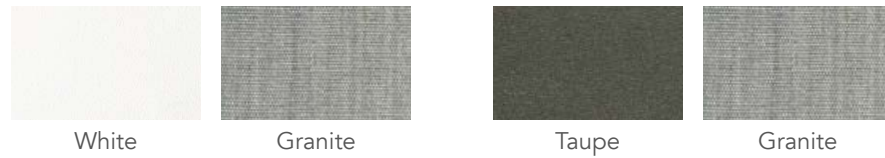

## Arm Chair

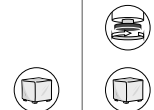

## Dining Table 4 Seater



## Dining Table 4 Seater



## Dining Table 6 Seater



## Lounge Chair

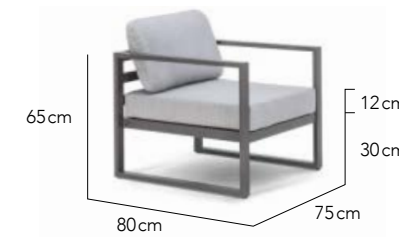

## 2 Seater Sofa



## 3 Seater Sofa

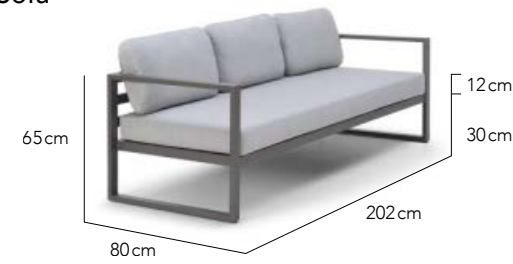

## Corner Module



NEW

## Left Module S

NEW

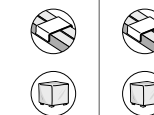
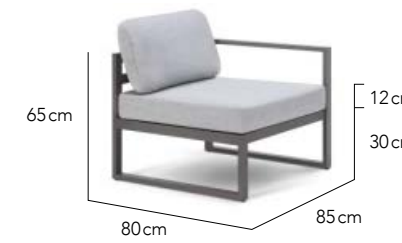

## Right Module S

NEW

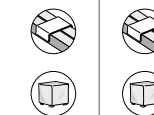

## Left Module L

NEW

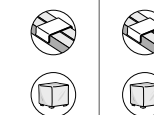

## Right Module L

NEW

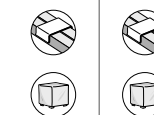

## Centre Module S

NEW

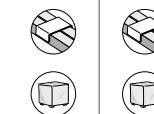

## Centre Module L

NEW

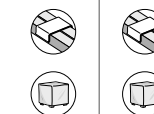



Backless Module / Ottoman S

NEW

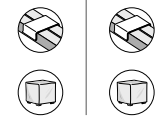

Backless Module / Ottoman L

NEW



Chaise Longue L

NEW



Chaise Longue R

NEW

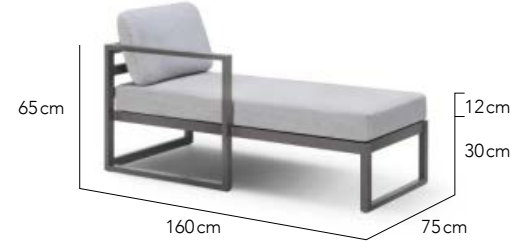

Side Table

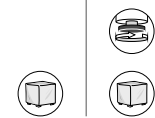

Coffee Table



Coffee Table

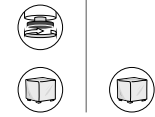

Optional Lounge Back Cushion Angular Style



FIBRE & POWDER COATING  
OPTIONS | 144

TEAK TREATED WITH BERGER MARINE VARNISH

MORE FABRIC OPTIONS | 146 - 147

GLASS INSERT TABLE TOP OPTION | 148

ACCENT CUSHION OPTIONS | 132 - 133



Sample Configurations

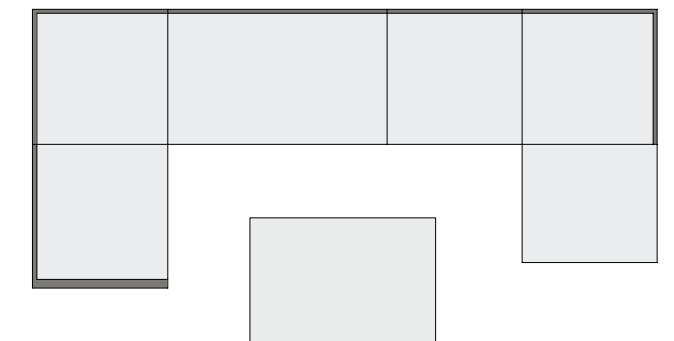
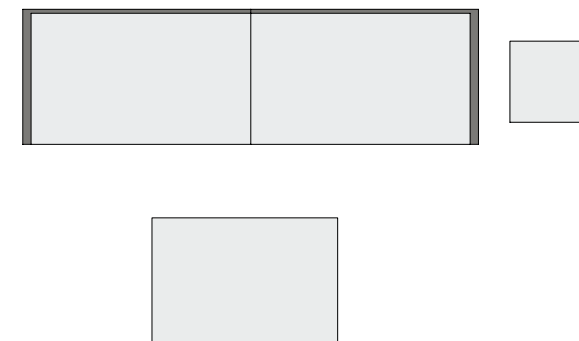
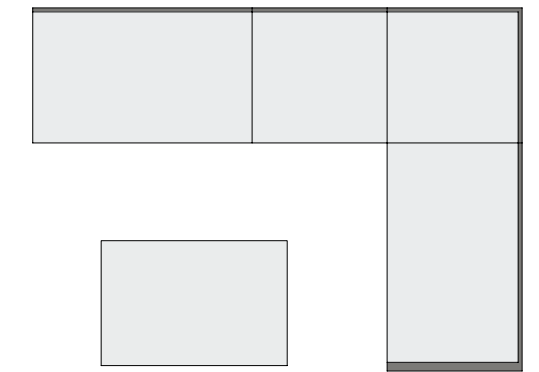
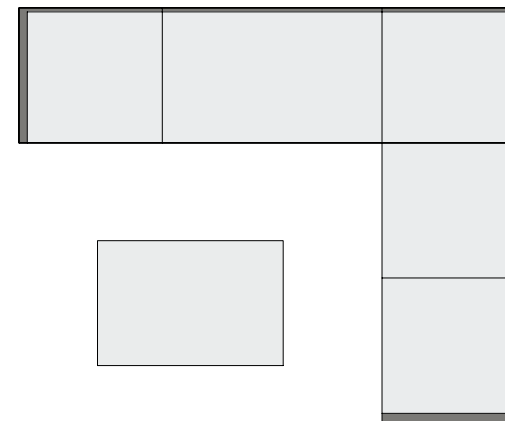



# LINEAR

DESIGNED BY  
Kevin Boland

CHARACTERISTICS  
Minimal | Versatile | Practical



RECOMMENDED FINISHING PAIRINGS



Stool

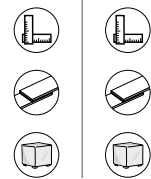

Bench Medium

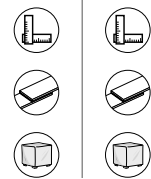

Table Medium

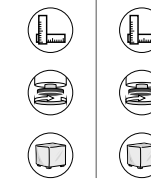
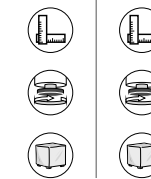

Table Large



Bench Large

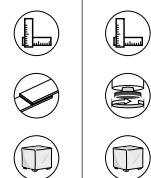
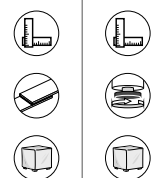

Table Small



 MORE FIBRE OPTIONS | 142

 MORE FABRIC OPTIONS | 146 - 147

TABLE TOP OPTIONS | 148





# MANTRA

DESIGNED BY  
OHMM® Design Studio

CHARACTERISTICS  
Modular | Rectilinear | Industrial | Masculine



## RECOMMENDED FINISHING PAIRING

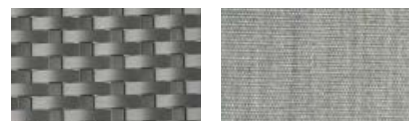

Platinum & Silver

Granite

## Lounge Chair

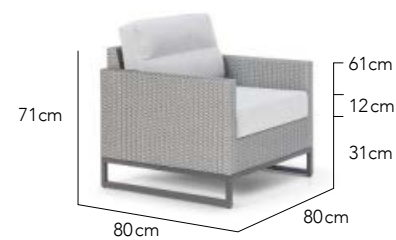

## 2 Seater Sofa



## Corner Module

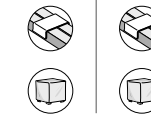

## Left Module S



## Right Module S

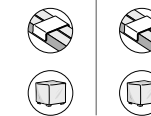
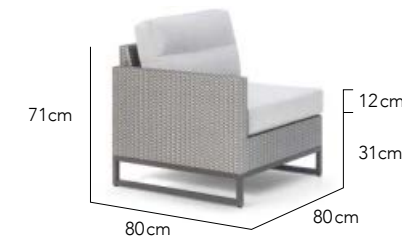

## Left Module L



## Right Module L

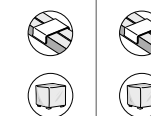

## Centre Module S



## Centre Module L

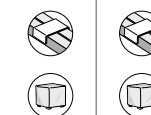

## Backless Module / Ottoman S



## Backless Module / Ottoman L

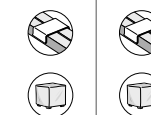

## Chaise Longue L



## Chaise Longue R

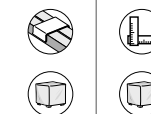
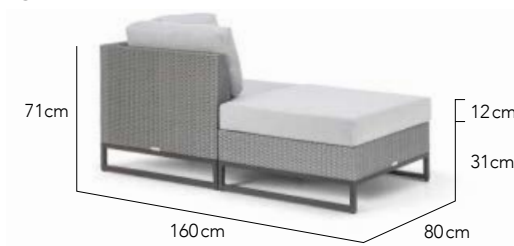

## Side Table

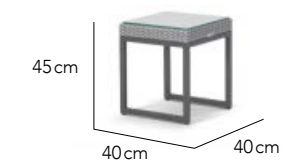



Coffee Table

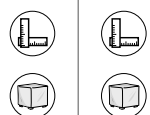
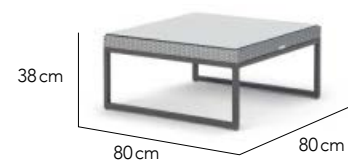

Coffee Table

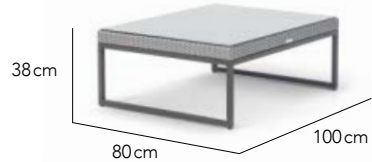

FIBRE & POWDER COATING  
OPTIONS | 145

MORE FABRIC OPTIONS | 146 - 147

ACCENT CUSHION OPTIONS | 132 - 133

TABLE TOP OPTIONS | 148



FIBRE  
FULLY WOVEN



FIBRE &  
CLEAR GLASS

Sample Configurations

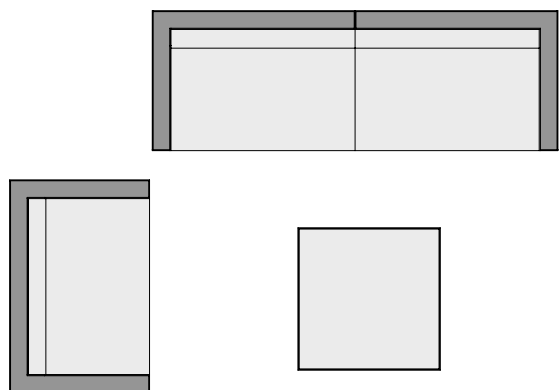
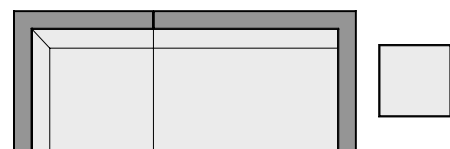
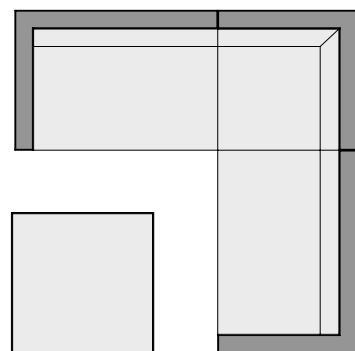
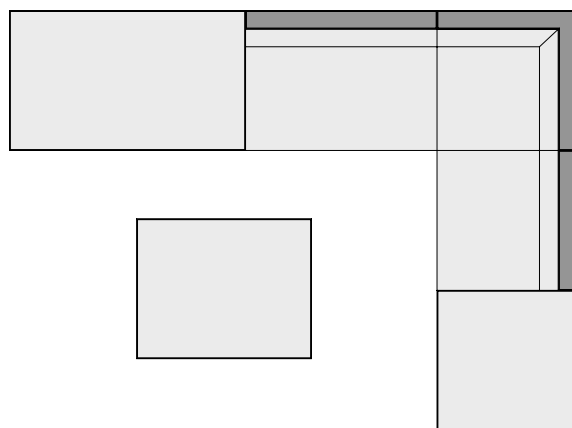







# MAXIMUS

## NEW MODULAR ELEMENTS

DESIGNED BY  
Kevin Boland

CHARACTERISTICS  
Majestic | Generous | Formal | Stately



### RECOMMENDED FINISHING PAIRINGS

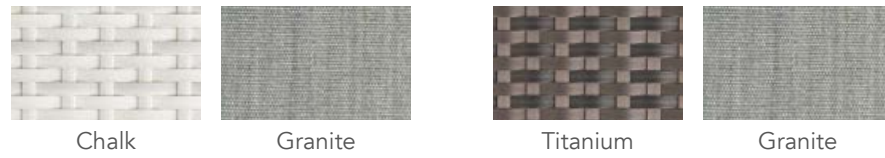

### Arm Chair

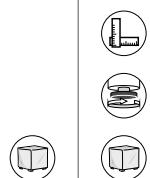

### Dining Table



### Dining Table

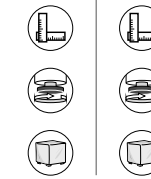

### Dining Table



### Dining Table

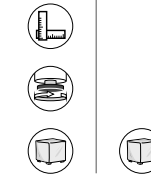

### Lounge Chair



### 2 Seater Sofa



### 3 Seater Sofa



### Corner Module

NEW

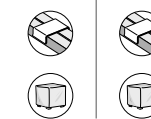

### Left Module

NEW



### Right Module

NEW

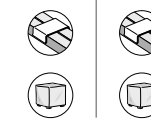

### Centre Module S

NEW



### Arm Chair

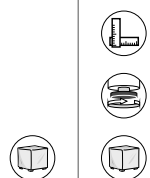

### Dining Table



### Centre Module L

NEW

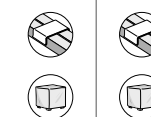

### Backless Module / Ottoman

NEW





Chaise Longue L



Modular & Stand Alone Versions available



Chaise Longue R



Modular & Stand Alone Versions available

Foot Stool



NEW



Side Table



Coffee Table



Coffee Table



Sun Lounger



Sun Lounger Side Table



 MORE FIBRE OPTIONS | 142

 MORE FABRIC OPTIONS | 146 - 147

 ACCENT CUSHION OPTIONS | 132 - 133

 OPTIONAL SUN LOUNGER HEADRESTS | 149

TABLE TOP OPTIONS | 148



FIBRE FULLY WOVEN



FIBRE & CLEAR GLASS



FROSTED GLASS INSERT



Sample Configurations

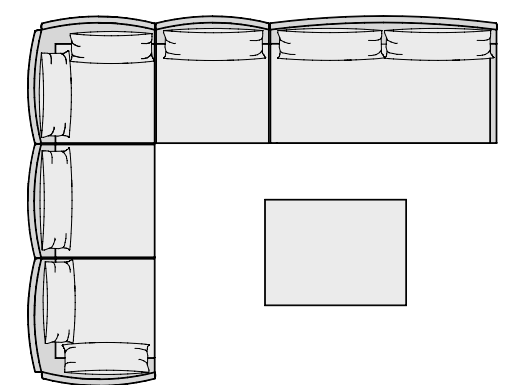
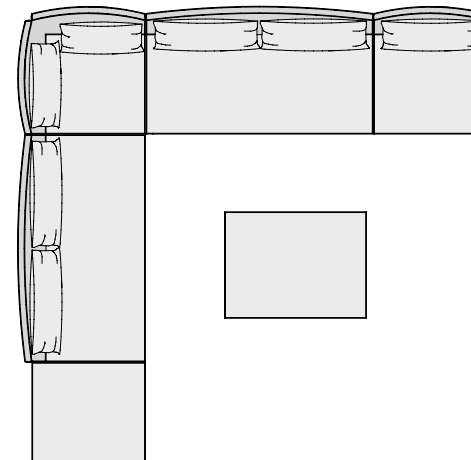
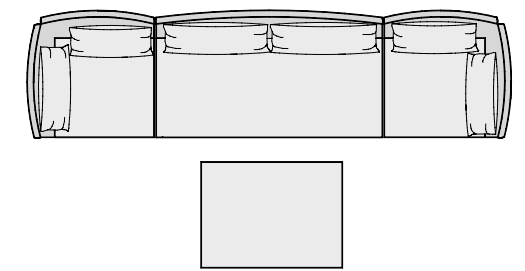
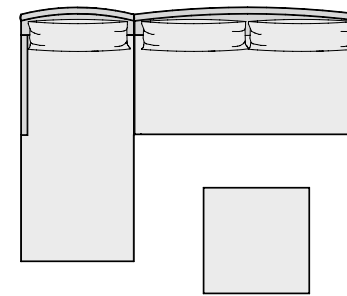







# MODULO

NEW '321' WEAVE

DESIGNED BY  
OHMM® Design Studio

CHARACTERISTICS  
Modular | Versatile | Robust



## RECOMMENDED FINISHING PAIRINGS

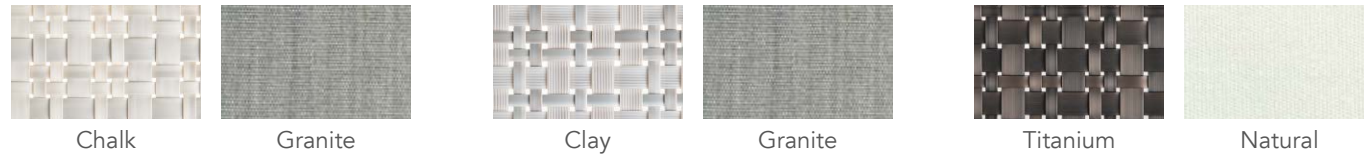

Lounge Chair

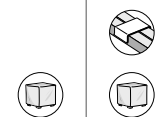

Corner Module

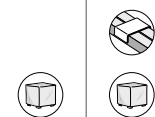

Left Module

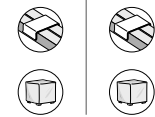

Right Module

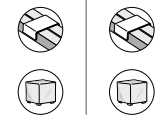

Centre Module S

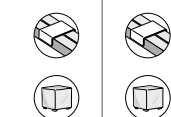

Centre Module M

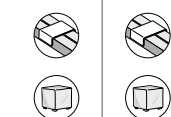

Centre Module L

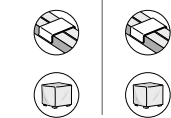

Curved Module

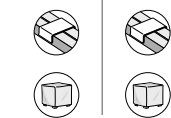

Backless Module / Ottoman S

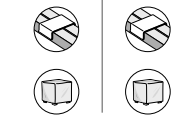

Backless Module / Ottoman M

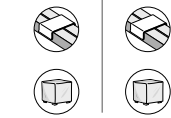

Backless Module / Ottoman L

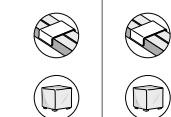

Chaise Longue S



Chaise Longue M

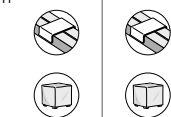

Chaise Longue L



Ottoman / Foot Stool



Side Table







Coffee Table S

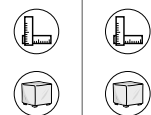

Coffee Table M

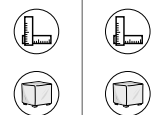

Coffee Table L

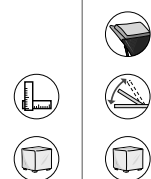

Sun Lounger

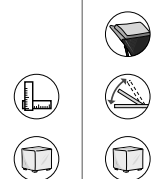

Sun Lounger Double

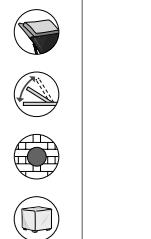

Sample Configurations

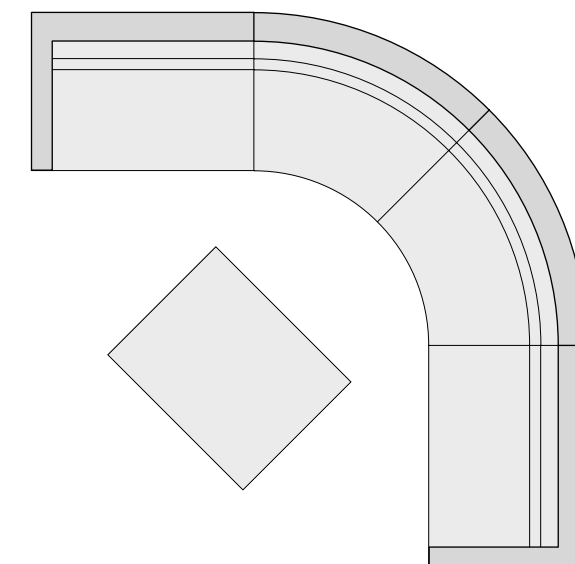
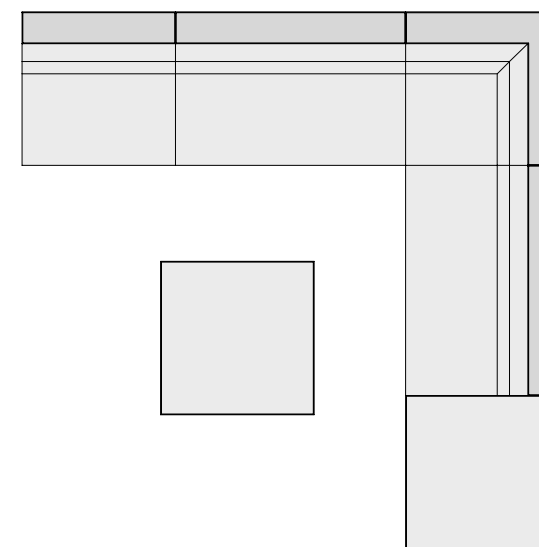
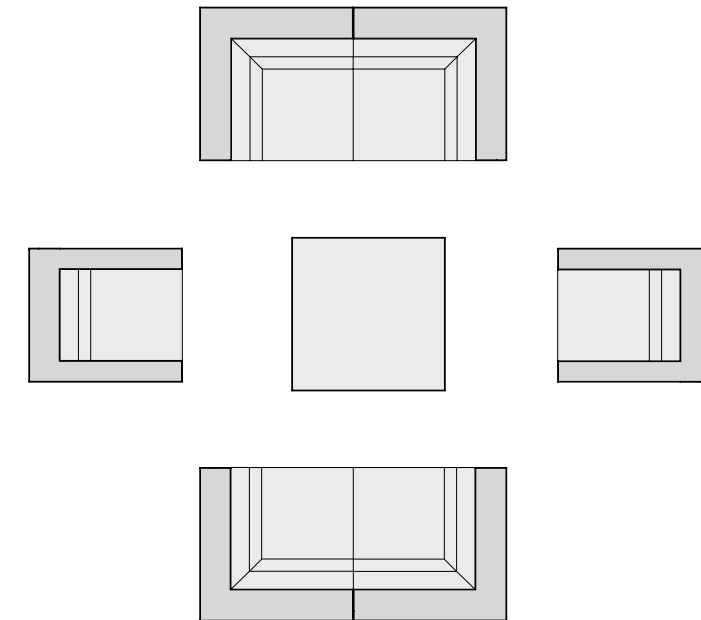
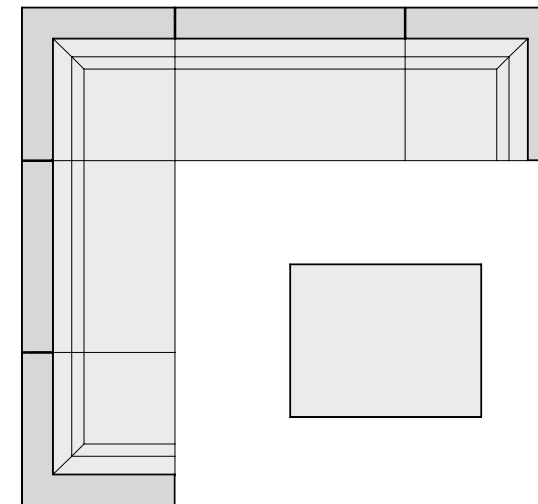





-  MORE FIBRE OPTIONS | 143
-  MORE FABRIC OPTIONS | 146 - 147
-  ACCENT CUSHION OPTIONS | 132 - 133
-  OPTIONAL SUN LOUNGER HEADRESTS | 149

TABLE TOP OPTIONS | 148



FIBRE FULLY WOVEN



FIBRE & CLEAR GLASS







# NOVO

DESIGNED BY  
OHMM® Design Studio

CHARACTERISTICS  
Handsome | Relaxed | Inviting



## RECOMMENDED FINISHING PAIRINGS

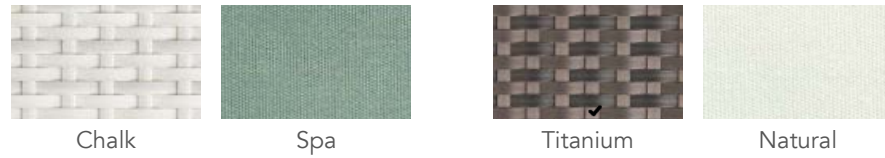

### Side Chair

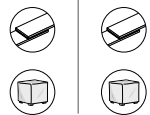

### Arm Chair





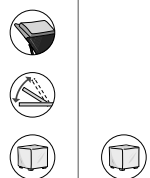

NEW

### Sun Lounger



### Side Table



-  MORE FIBRE OPTIONS | 142 - 143
-  MORE FABRIC OPTIONS | 146 - 147
-  OPTIONAL SUN LOUNGER HEADRESTS | 149
-  COMBINES WELL WITH PARTU TABLES | 90 - 95







# PALM

## NEW MODULAR ELEMENTS

DESIGNED BY  
Kevin Boland

CHARACTERISTICS  
Splendorous | Classic | Ergonomic



### RECOMMENDED FINISHING PAIRINGS

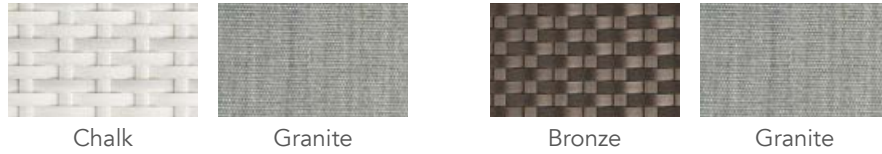

Chalk

Granite

Bronze

Granite

Dining Table

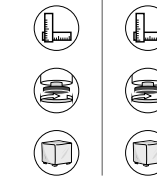

Dining Table



Dining Table

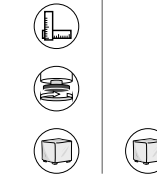

Lounge Chair



2 Seater Sofa



3 Seater Sofa



Corner Module



NEW

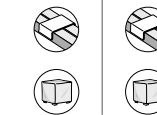

Left Module



NEW

Side Chair

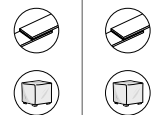

Arm Chair



Right Module



NEW

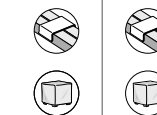

Centre Module S



NEW

2 Seater Arm Chair

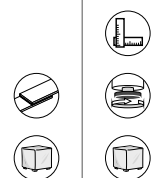

Dining Table



Centre Module L



NEW

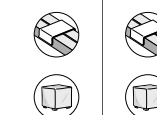

Backless Module / Ottoman



NEW



Chaise Longue L



Modular & Stand Alone Versions available



Chaise Longue R



Modular & Stand Alone Versions available

Foot Stool



Side Table



Coffee Table

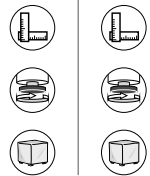

Coffee Table



Bar Stool

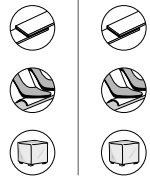

Bar Chair



Bar Table

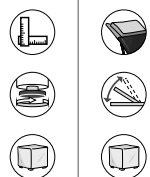

Sun Lounger



Sun Lounger Double

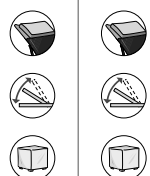

Sun Lounger with Wheels



Sample Configurations

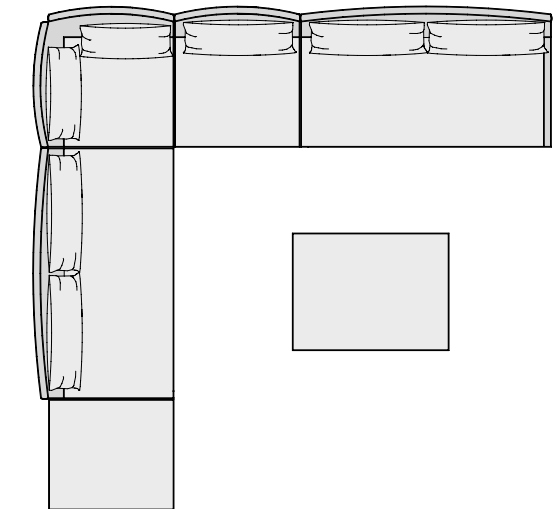
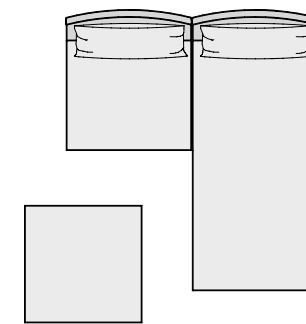
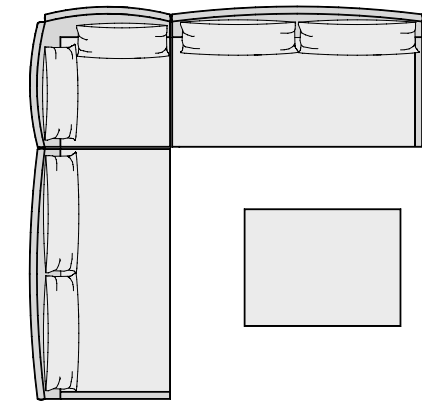
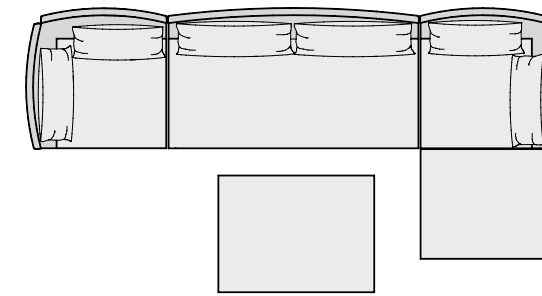

Sun Lounger with Wheels



Sun Lounger Side Table



MORE FIBRE OPTIONS | 142

MORE FABRIC OPTIONS | 146 - 147

ACCENT CUSHION OPTIONS | 132 - 133

OPTIONAL SUN LOUNGER HEADRESTS | 149

TABLE TOP OPTIONS | 148



FIBRE FULLY WOVEN



FIBRE & CLEAR GLASS



FROSTED GLASS INSERT











# PARTU

DESIGNED BY  
OHMM® Design Studio

CHARACTERISTICS  
Smart | Minimal | Versatile



Dining Table

NEW

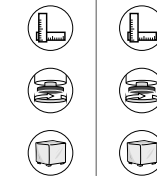
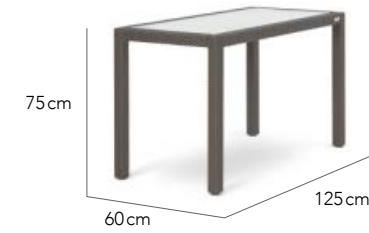

Dining Table



Dining Table

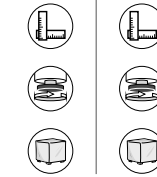

Dining Table

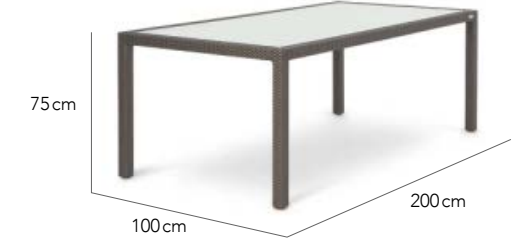

Dining Table

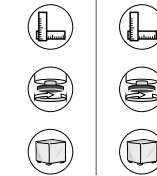

Dining Table

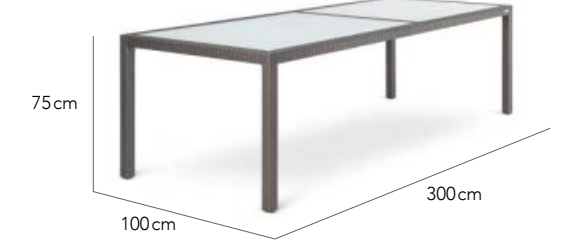

Side Table

NEW

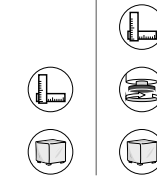

Coffee Table



Dining Table

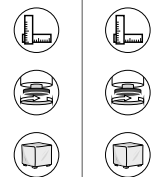

Dining Table



Coffee Table

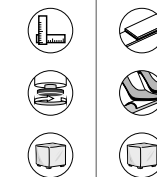

Bar Stool

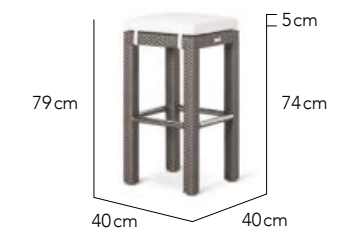

NEW

Dining Table

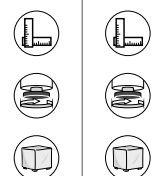

Dining Table



Bar Table

NEW

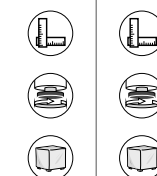

Bar Table



NEW



Bar Table

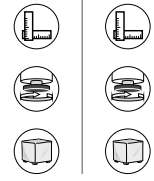

Bar Table



 FIBRE OPTIONS | 142

 COMBINES WELL WITH ALL OHMM PRODUCTS

TABLE TOP OPTIONS | 148



FIBRE  
FULLY WOVEN



FIBRE &  
CLEAR GLASS



FROSTED  
GLASS INSERT









# SOL

DESIGNED BY  
Kevin Boland

CHARACTERISTICS  
Soulful | Fun | Distinctive



## RECOMMENDED FINISHING PAIRING

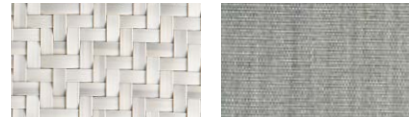

Chalk

Granite

## Lounge Chair



## Day Bed S



## Day Bed L



## Stool



## Ottoman S



## Ottoman L



## Side Table



## Coffee Table S

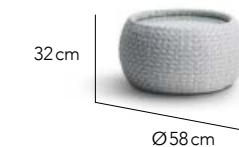

## Coffee Table L



 MORE FIBRE OPTIONS | 143

 MORE FABRIC OPTIONS | 146 - 147

 ACCENT CUSHION OPTIONS | 132 - 133

## TABLE TOP OPTIONS | 148



FIBRE  
FULLY WOVEN



FIBRE &  
CLEAR GLASS











# SUMMER LIGHT

DESIGNED BY  
Kevin Boland

CHARACTERISTICS  
Minimalistic | Light | Versatile



## RECOMMENDED FINISHING PAIRINGS

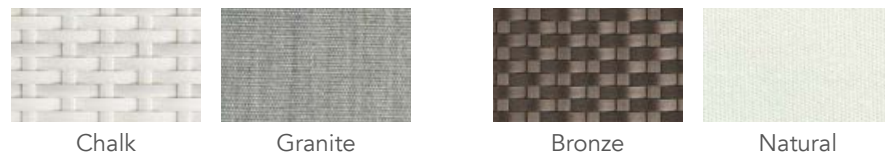

Lounge Chair



2 Seater Sofa



3 Seater Sofa

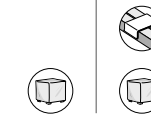

Corner Module



Left Module

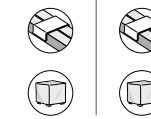

Right Module



Centre Module S

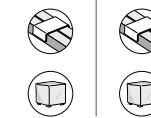

Centre Module L



Backless Module S / Ottoman

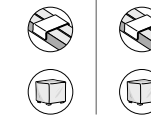

Backless Module L



Chaise Longue L

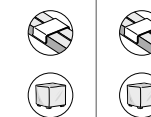

Chaise Longue R



Foot Stool

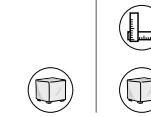

Side Table





Coffee Table

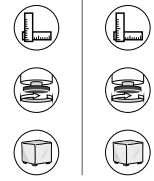

Coffee Table

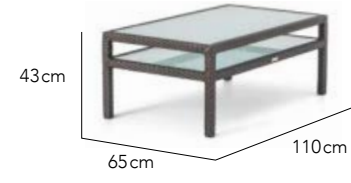

 MORE FIBRE OPTIONS | 142

 MORE FABRIC OPTIONS | 146 - 147

 ACCENT CUSHION OPTIONS | 132 - 133

TABLE TOP OPTIONS | 148



FIBRE FULLY WOVEN



FIBRE & CLEAR GLASS



FROSTED GLASS INSERT

Sample Configurations

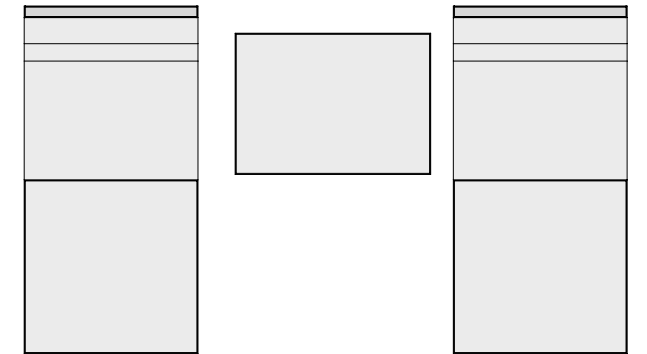
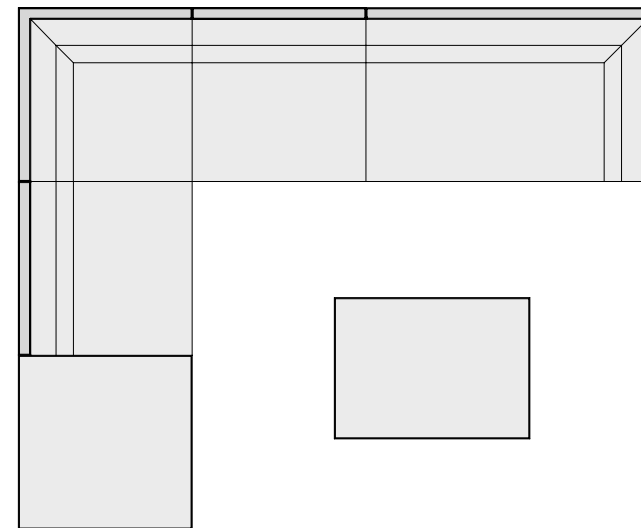
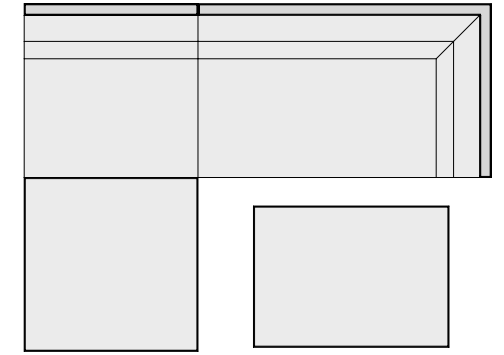
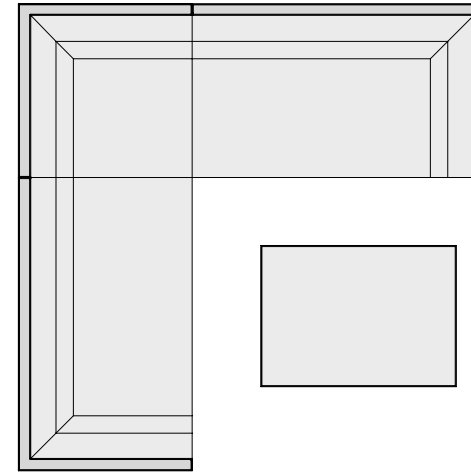









# TAMARU

DESIGNED BY  
Kevin Boland

CHARACTERISTICS  
Curvaceous | Cocooning | Pampering



RECOMMENDED FINISHING PAIRINGS

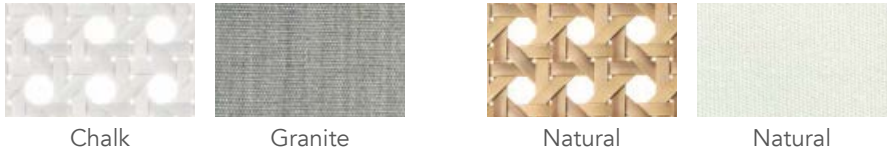



Day Bed

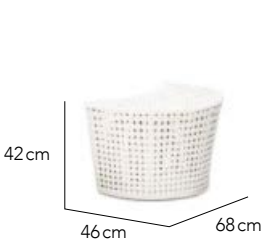

Half Moon Side Table



-  MORE FIBRE OPTIONS | 144
-  MORE FABRIC OPTIONS | 146 - 147
-  ACCENT CUSHION OPTIONS | 132 - 133







# TRES

DESIGNED BY  
Kevin Boland

CHARACTERISTICS  
Eclectic | Minimalistic | Versatile



Dining Table



Dining Table

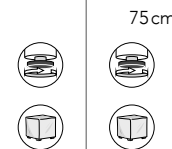

POWDER COATING OPTIONS | 145

TEAK TREATED WITH BERGER MARINE VARNISH

COMBINES WELL WITH ALL CHAIRS







# WAVE

DESIGNED BY  
Kevin Boland

CHARACTERISTICS  
Curvaceous | Flowing | Sleek



## RECOMMENDED FINISHING PAIRINGS



Chalk



Granite



Natural



Taupe

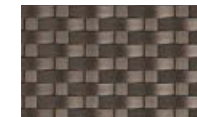

Bronze



Natural

## Sun Lounger



## Side Table



 MORE FIBRE OPTIONS | 142

 MORE FABRIC OPTIONS | 146 - 147

 OPTIONAL SUN LOUNGER HEADRESTS | 149



# ZEN

DESIGNED BY  
OHMM® Design Studio

CHARACTERISTICS  
Jaunty | Minimalistic | Unpretentious



## RECOMMENDED FINISHING PAIRINGS



### Arm Chair

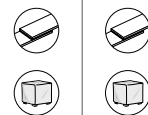

### 2 Seater Arm Chair

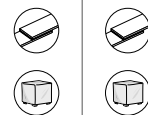

### Club Chair

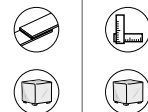

### Club Chair Side Table



### Club Chair Foot Stool / Ottoman

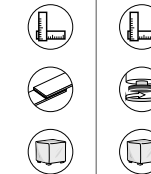

### Coffee Table



### Coffee Table

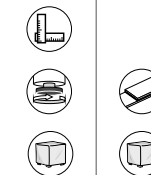

### Bar Arm Chair



### Sun Lounger



Optional Headrest without cushion

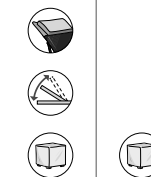

### Sun Lounger Side Table



MORE FIBRE OPTIONS | 142 - 143

MORE FABRIC OPTIONS | 146 - 147

ACCENT CUSHION OPTIONS | 132 - 133

COMBINES WELL WITH PARTU TABLES | 90 - 95

### TABLE TOP OPTIONS | 148



FIBRE FULLY WOVEN



FIBRE & CLEAR GLASS







ECONOMY  
**PARASOLS**  
BY SHADEMAKER



DESIGNED BY  
Shademaker

CHARACTERISTICS  
Nautical | Contemporary | Durable

PREMIUM  
**PARASOLS**  
BY TUUCI



DESIGNED BY  
Dougan Clarke

CHARACTERISTICS  
Nautical | Stylish | Durable

**Libra**



Base 60kg with wheels



Square  
2m | 2.5m



Octagon  
2.5m | 2.7m

**Bay Master Classic**



Base 70kg wheels optional

Fibre Flex available for windy environments



Square  
2m | 2.25m | 2.6m



Octagon  
2.25m | 2.75m | 3.2m

**Sirius**



Base 160kg



Square  
2.7m | 3m



Octagon  
3m | 3.5m

**Bay Master | Ocean Master Cantilever**



Base 181kg | 272kg | 363kg



Square  
2.45m | 3m



Octagon  
2.75m | 3.4m

Canopy Colours



Oyster



Taupe

OTHER CANOPY COLOURS AVAILABLE ON REQUEST

OTHER MODELS AVAILABLE ON REQUEST

Canopy Colours



Natural



Platinum



Scalloped



Ecru

OTHER CANOPY COLOURS AVAILABLE ON REQUEST

OTHER MODELS AVAILABLE ON REQUEST







# LANTERNS NEW

DESIGNED BY  
OHMM® Design Studio

CHARACTERISTICS  
Classic | Curvaceous | Ambient



## FINISHING



Seashore

### Lantern XS

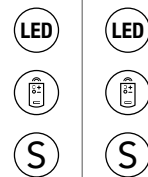

### Lantern S



### Lantern M

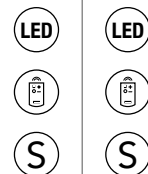

### Lantern L



### Lantern XL

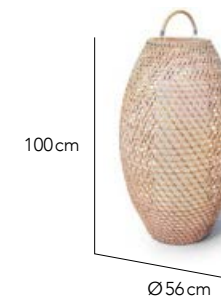

### Outdoor LED Light



Each lantern comes with a proportional sized LED

### 'S' Clip

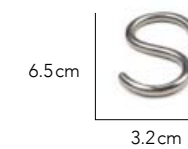

### LED Light Sizes

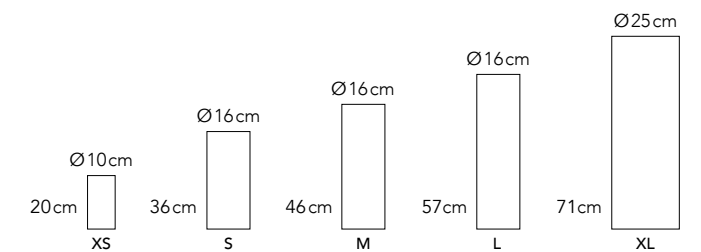

**LED** OUTDOOR LED LIGHT INCLUDED  
NUMEROUS LIGHTING OPTIONS  
RECHARGEABLE & CORDLESS

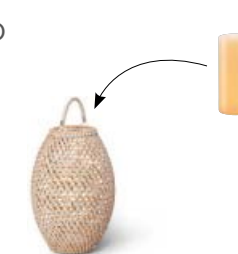

**RC** INCLUDES REMOTE CONTROL  
**S** 'S' CLIP FOR HANGING INCLUDED







# PLANTERS

DESIGNED BY  
OHMM® Design Studio

CHARACTERISTICS  
Classic | Complimentary | Versatile



## PREFERRED FINISHING OPTIONS



Chalk

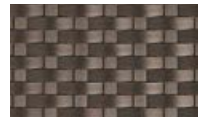

Bronze

Planter Tapered S



Planter Tapered M



Planter Tapered L

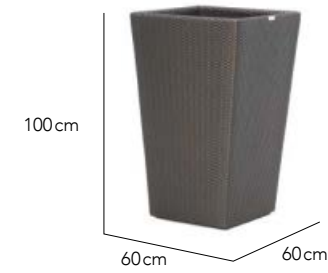

Planter Square S

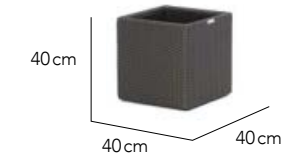

Planter Square M

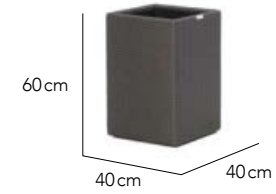

Planter Screen

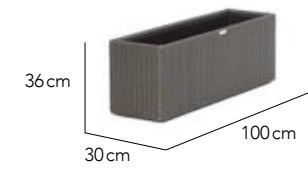

 MORE FIBRE OPTIONS | 142

INSERTS WITH HANDLES  
DRAINAGE HOLES OPTIONAL

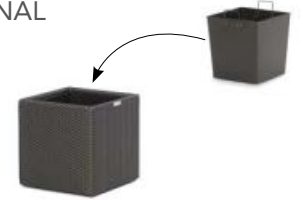



# SIDE TABLES

DESIGNED BY  
OHMM® Design Studio

CHARACTERISTICS  
Convenient | Functional | Versatile



C Table

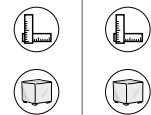
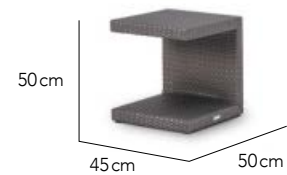

Top Cube

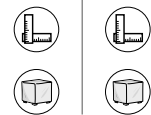

Glass Cube

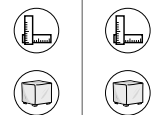
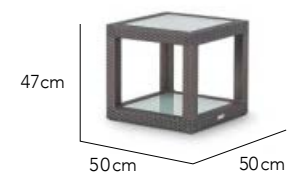

Sea Cube

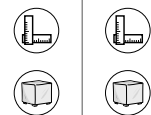
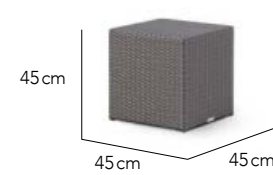

Sea Circle

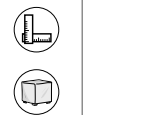

 FIBRE OPTIONS | 142  
 COMBINES WELL WITH ALL OHMM PRODUCTS

# FURNITURE COVERS



It's only natural to want to protect your OHMM® outdoor furniture at certain times of the year.

At OHMM® we have developed an outdoor cover solution using a high tech fabric from the USA - WeatherMAX®. Delivering exceptional durability, water repellency, UV-resistant (i.e. won't fade) with outstanding breathability and mildew resistance, the covers are light weight and easy to pack too.

WeatherMAX® fabric is not waterproof, but highly water repellent and breathable. Being breathable means it will help reduce dampness, heat build up and condensation, thus helping to prevent mould and mildew from forming on your furniture and cushions during storage.

It will withstand light showers but not sustained heavy downpours. Any accumulated water must be removed by gently raising one side of the cover.

OHMM® covers feature a hem around the base fitted with marine elastic cord and cord locks for securing them in place. The hem stops 5cm from the ground to allow air circulation to prevent moisture build up inside.

And there is a 5 year warranty against loss of fabric strength or colour loss.

Please contact us for a quotation for your OHMM® furniture.

Cover Colour

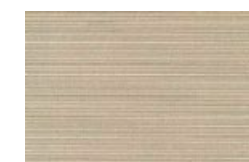

Beige

Piping Colour



Sand

Cover Colour

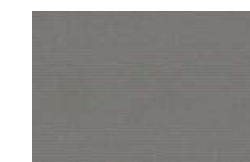

Charcoal

Piping Colour



Graphite



# ACCENT CUSHIONS

Discerningly handmade for that softness and ultimate comfort, OHMM® Accent Cushions are available in a range of heights and widths to create visually interesting layering and support.



OTHER SIZES AVAILABLE ON REQUEST

# FABRIC COLOURS

## CATEGORY A | SOLIDS



## CATEGORY B | TEXTURES



## CATEGORY C | PATTERNS







# PROJECTS

## CREATING INSPIRATIONAL OUTDOOR SPACES

For over 15 years OHMM® has been assisting clients create inspirational outdoor spaces for their guests to enjoy memorable relaxing times under the open skies. We recognise that creating a tangible guest experience is critical and when it comes to outdoor furniture, being comfortable is a given, but it must add an aesthetically pleasing visual impact.

To this end, we offer a versatile range of collections, together with options to customise in size and with an unparalleled choice of fibre and fabric finishes

## CUSTOMISED TO YOUR NEEDS

## AFFORDABLE WORLD CLASS QUALITY

We own and manage our own production in Cebu, home to the world's best woven furniture craftsmen. We are not a mass producer, which means our levels of quality, finishing and attention to detail are unrivalled. That simply adds up to world class quality for you. And you are not paying for a big brand name.

We believe our solid track record speaks for itself with a host of world class companies as clients. See our website for a list of project references.

## TRACK RECORD

## 3 YEAR PROJECT WARRANTY

We stand behind our products with a 3 year project warranty covering workmanship and materials.











# CUSTOMISE

## STYLE IT YOUR WAY

We recognise that we all have different needs and tastes and outdoor spaces where 'one size doesn't fit all'. That's why we offer you the choice to customise your OHMM® furniture your way.

Choose from a wide line up of fibre colours to a versatile curation of fabric colours, and you have the freedom to create your own individual décor look. Unique to you.

## CHOOSE YOUR FINISHING COLOURS

## CUSTOMISE

If you need custom sizing of tables or a certain OHMM® collection customised to fit your needs don't hesitate to ask. We'll do what we can.

And if you would like some recommendations, we have years of experience in the creation of outdoor spaces - both residential and projects - from space planning, collection mix and choice of finishing colours.

## HERE TO HELP

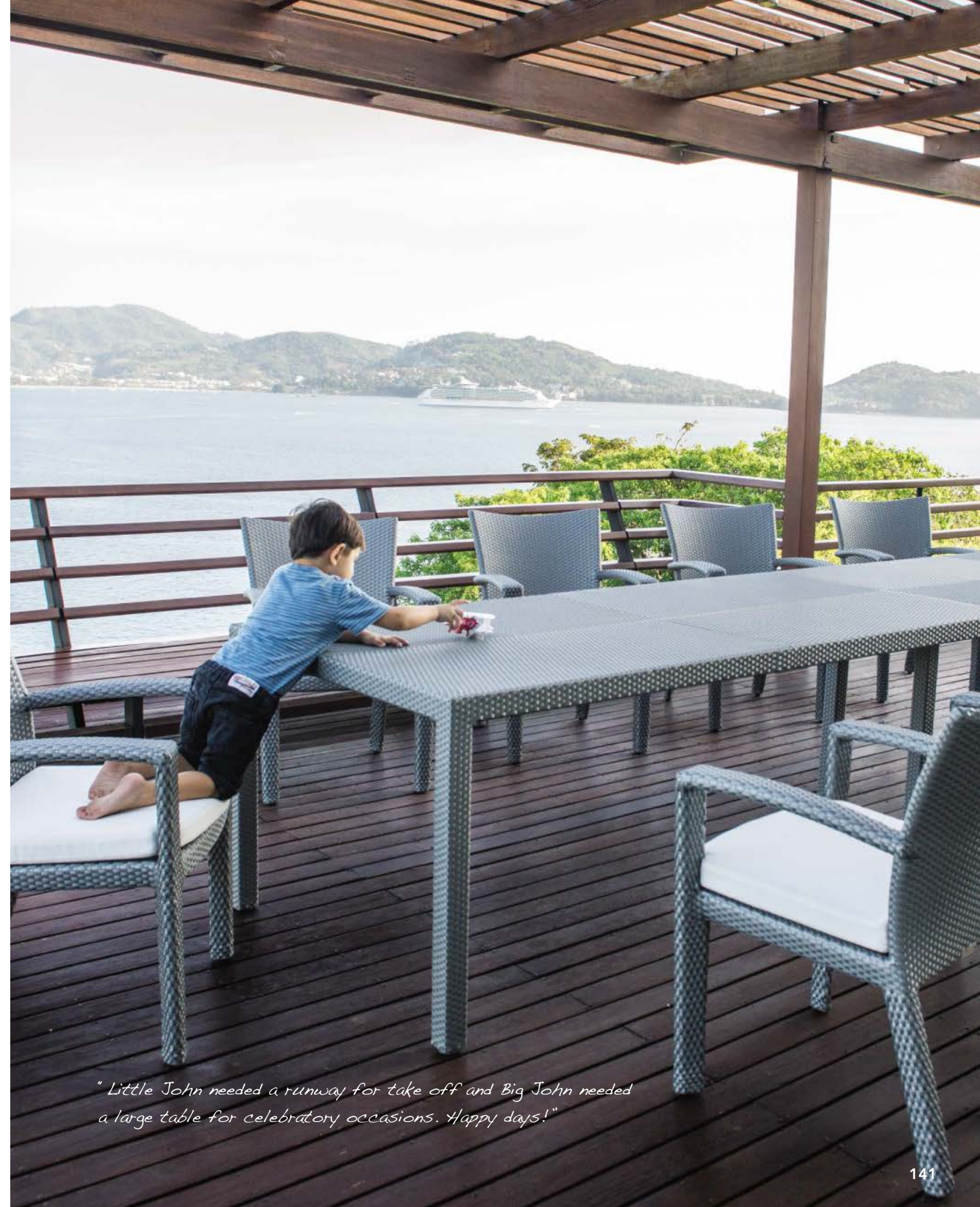

*"Little John needed a runway for take off and Big John needed a large table for celebratory occasions. Happy days!"*



# FIBRE & POWDER COATINGS

OHMM® has teamed up with Rehau® - the most recognised and trusted name worldwide in polymer technology for over fifty years. Raucord synthetic rattan is manufactured using renowned German engineering know how and production technology.

Due to its superior characteristics, Raucord fibre offers a carefree outdoor experience.

UV-resistant | Weatherproof | Temperature Resistant | Strong & Durable | Low Maintenance | Easy to Clean | Non-toxic | Environmentally Friendly | Colourfast | Scratch & Stain Resistant

## 7MM '1X1' WEAVE

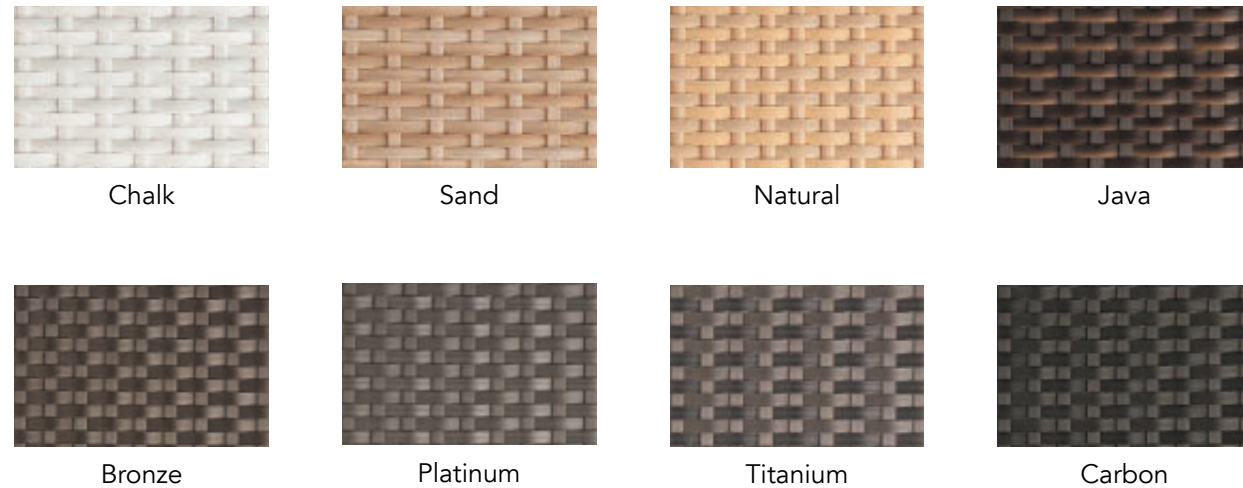

- BEACH
- CABANA
- CATALONIA
- CLASSIC
- ECLIPSE
- FLO
- INTI
- LINEAR
- MAXIMUS
- NOVO
- PALM
- PARTU
- PLANTERS
- SIDE TABLES
- SUMMER LIGHT
- WAVE
- ZEN

## 6MM HERRINGBONE WEAVE

FIESTA



## 7MM HERRINGBONE '2X2' WEAVE

HORIZON  
HORIZON MINI  
KEYWEST  
KYOTO  
SOL



## 7MM OPEN WEAVE

BEACH  
FLO  
NOVO  
ZEN

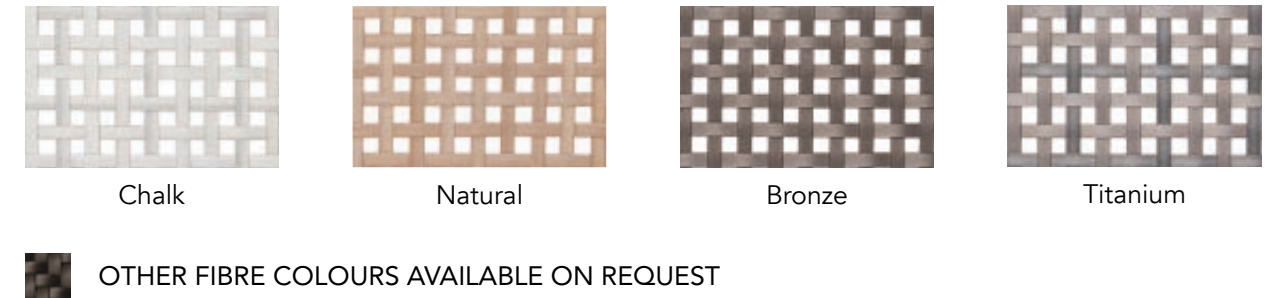

## 13 X 7MM '321' WEAVE

NEW WEAVING STYLE

MODULO

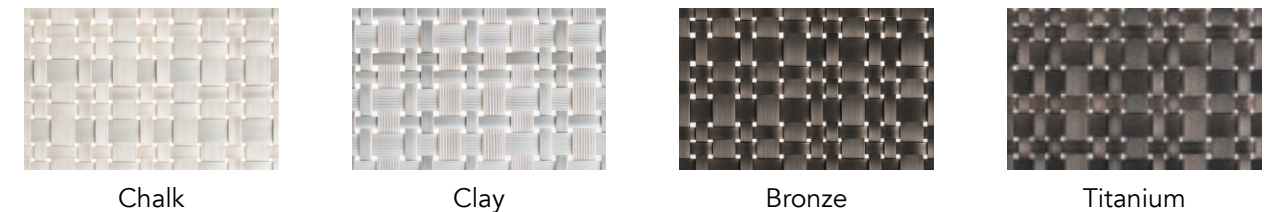



7MM CANING WEAVE

TAMARU



Chalk



Natural

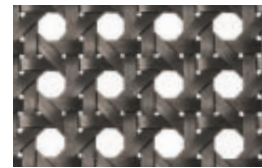

Bronze



OTHER FIBRE COLOURS AVAILABLE ON REQUEST

7MM HEX WEAVE

LANTERNS



Seashore

7MM '321' WEAVE NEW WEAVING STYLE

LATITUDES



Chalk



Silver

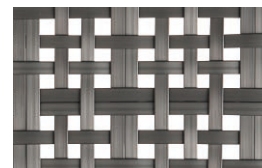

Platinum

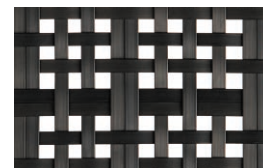

Carbon

7MM '1X1' WEAVE



Chalk



Silver



Platinum



Carbon

POWDER COAT PAIRINGS

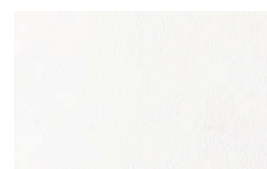

White

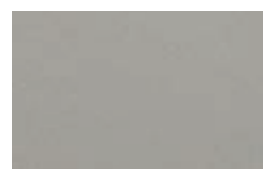

Silver

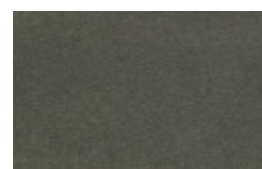

Taupe

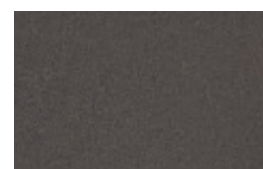

Asteroid

7MM '1X1' WEAVE

MANTRA

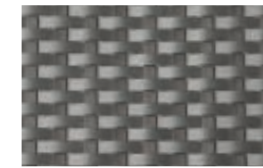

Platinum & Silver

POWDER COAT PAIRING



Asteroid

7MM '1X1' WEAVE



Chalk



Platinum

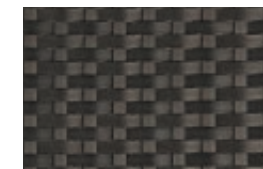

Carbon

POWDER COAT PAIRINGS

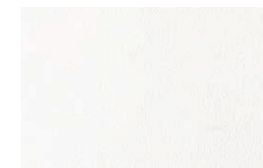

White

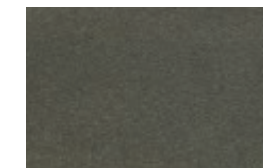

Taupe

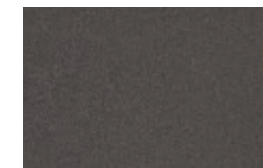

Asteroid

POWDER COATINGS

TRES

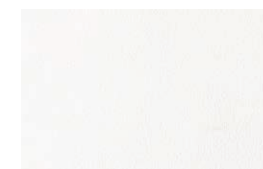

White

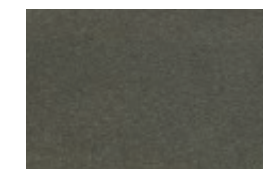

Taupe

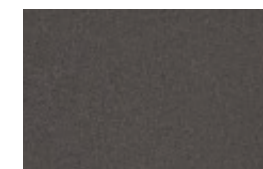

Asteroid



# CUSHIONS

Working with artisanal sofa makers and foam manufacturers, OHMM® cushions are expertly designed for support, comfort and durability using the latest material technology.

We use high density foam cores to ensure lasting performance, covered with Dacron® polyester fibre for comfort and good looks, then lined with replaceable water resistant spunbond material, and finally covered with Sunbrella® fabric.

We stitch using high quality German polyester threads and use robust nylon zippers and runners to ensure durability and fuss free usage.

# FABRICS

Only the best. Sunbrella®. The most recognised and trusted name worldwide in outdoor fabrics for over fifty years - it all adds up to unparalleled performance and good looks.

Colourfast | Fade Resistant | Durable | Water Repellent | Stain Resistant | Mould Resistant | Luxurious Touch | Breathable | Environmentally Friendly | Easy Care

OHMM® Design Studio has carefully curated a colour palette of Sunbrella® fabrics giving you the freedom to play with colours and textures to style it your way and create a unique and inspiring ensemble.

# FABRIC COLOURS

## RECOMMENDED FOR SEAT & BACK CUSHIONS

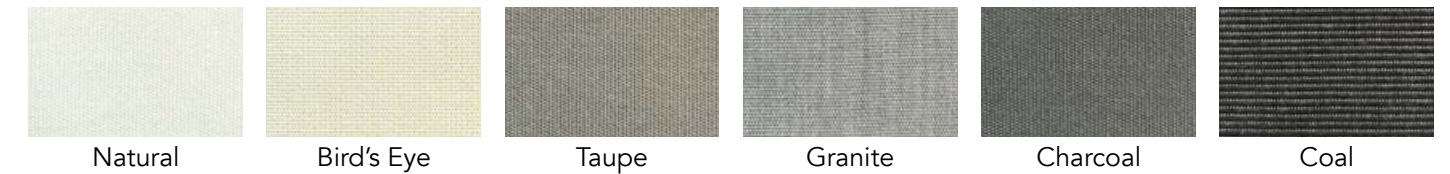

## RECOMMENDED FOR ACCENTS CATEGORY A | SOLIDS



## CATEGORY B | TEXTURES

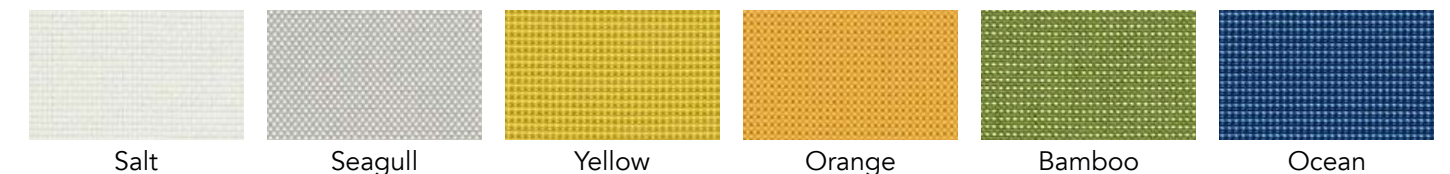

## CATEGORY C | PATTERNS



\* Full Sunbrella® range available on request basis for projects  
\* Client's own material welcome



# TABLE TOP SPECIFICATIONS



Fibre Fully Woven Standard

Fully woven top in the standard weave of the collection. No glass.



Fibre Fully Woven Quartered

Fully woven top in the standard weave of the collection with the top woven in 4 sections. No glass.



Fibre & Clear Glass

Clear tempered glass. 6mm thickness. Edges chamfered. Corners rounded. Set in 10mm from the edge of the table for better looks and comfort. Glass anchors to keep glass secure and raised slightly above fibre. Removable.



Frosted Glass Insert

Frosted tempered glass. 8mm thickness on tables up to 180x100cm. 10mm thickness on tables larger than 180x100cm. Edges chamfered. Corners rounded. Fitted flush to top of woven border. Adjustable glass supports for minor adjustment. Removable.



Teak & Woven Frame

Partu tables, with premium teak slat inserts sourced from sustainable plantations. 10mm thickness on coffee and side tables. 12mm on dining tables. Edges chamfered and corners slightly rounded for comfort. Coated with high quality Berger Marine Varnish to create and maintain a premium looking finish, eliminate maintenance as well as no staining and easy clean up.



Teak & Powder Coat Frame

Premium teak slats sourced from sustainable plantations. 10mm thickness on coffee and side tables. 12mm on dining tables. Edges chamfered and corners slightly rounded for comfort. Coated with high quality Berger Marine Varnish to create and maintain a premium looking finish, eliminate maintenance as well as no staining and easy clean up.

# ICONS & OPTIONAL DESIGN FEATURES



CUSTOM SIZING

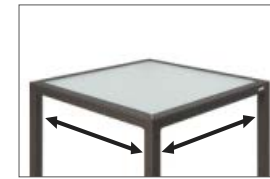

Tables



OPTIONAL CUSHION STRAPS



Chairs & Stools



PROTECTIVE FOOTRESTS



Bar Stools & Chairs



ADJUSTABLE GLIDERS



Tables



CLIPS



Modular Items



GLASS ANCHORS

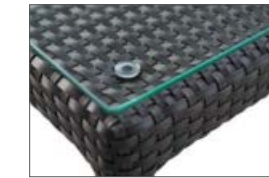

Tables



PROTECTIVE FERRULES



Chairs & Tables



OPTIONAL PARASOL HOLE

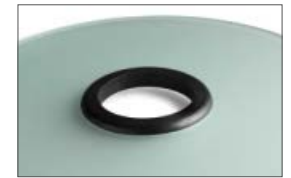

Tables



OPTIONAL WHEELS



Sun Loungers



OPTIONAL SUN LOUNGER HEADRESTS



Optional with or without cushion



OPTIONAL COVERS



All Products

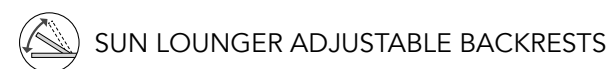

SUN LOUNGER ADJUSTABLE BACKRESTS



Snooze



Dream



Chill



Read



# HANDCRAFTED QUALITY

## WAY OF LIFE

In the same way as fibre is hand woven onto our frames, a quality ethos is woven through our company culture. It's how we go about our everyday lives. How we treat our customers, look after our people, how we conduct ourselves and ultimately our quality of life and impact on the planet.

We only use the best quality materials we can find. And yes, something that is designed to last must have been made using the very best materials. No cutting corners. It's what we touch and feel.

## BEST MATERIALS

## ENDURING DESIGNS

But quality means more to us than just the materials alone. Quality is also about design. Designs that are enduring and timeless so customers won't grow tired of them but come to cherish them. No trendy designs that are designed for a season and afterwards fall out of fashion and get discarded.

And to make world class quality products, we need world class craftsmen. That's why we have based OHMM® Manufacturing on the island of Cebu, home to the world's best woven craftsmen. A little known secret.

## IN-HOUSE WORLD CLASS CRAFTSMANSHIP

## OBSESSIVE OVER QUALITY

During our fifteen year journey, by making our products day in day out, we've built up a tremendous amount of expertise. We've become obsessive over quality, because we know that the quality of our product is our best advertising.

Good for our customers. Good for us.  
Good for Mother Earth too.

## MAKES SENSE





# WHY WOVEN?

## GOOD QUESTION

It's a good question. Well frankly, when we started in the industry, woven synthetic rattan was the new outdoor material. We fell in love with it.

Over the years we have experimented with other materials. Stainless steel is not stainless. It will 'tea stain' and rust if not regularly maintained. Mesh is not very robust and after some time is prone to sag and mould. Difficult to replace too. Teak, if not treated with a marine varnish will 'patina' - go greyish and not look very premium, especially when combined with modern materials. Bottom line, we found they all don't add up to great looks and performance. Not good for clients. Not good for us.

## WE FOCUS ON WOVEN

So we leave it to others to make products from these materials. And we just focus on making high quality woven products with the best quality synthetic rattan in the world and the best woven craftsmen in the world. Not only does synthetic rattan last with its robust physical properties and low maintenance, it comes in a wide choice of colours and profiles allowing greater design freedom. It's also repairable too.

After more than fifteen years in the industry, common sense has taught us woven furniture is enduring above all other materials. So, we focus on woven.

## OTHER MATERIALS

## MAKES SENSE





## LEARN MORE | WWW.OHMM.SG

Visit [www.ohmm.sg](http://www.ohmm.sg) for a host of downloadable resources - e-catalogue, spec sheets, product thumbnails, fibre and fabric details, warranty, care and maintenance and much more.

### CONTACT US

#### HQ | INTERNATIONAL

OHMM® International  
30 Merchant Road  
03-09 Riverside Point  
Singapore 058282  
T +65 6836 2747  
E [hello@ohmm.sg](mailto:hello@ohmm.sg)  
W [www.ohmm.global](http://www.ohmm.global)

#### SINGAPORE

OHMM® Singapore  
30 Merchant Road  
03-09 Riverside Point  
Singapore 058282  
T +65 6836 2747  
E [hello@ohmm.sg](mailto:hello@ohmm.sg)  
W [www.ohmm.sg](http://www.ohmm.sg)

#### PHILIPPINES

OHMM® Philippines  
Zone Sikwa, S Jayme Street  
Paknaan, Mandaue City  
6014 Cebu, Philippines  
M +63 (0) 917 595 9790  
E [hello@ohmm.ph](mailto:hello@ohmm.ph)  
W [www.ohmm.ph](http://www.ohmm.ph)

#### MANUFACTURING

OHMM® Manufacturing  
Zone Sikwa, S Jayme Street  
Paknaan, Mandaue City  
6014 Cebu, Philippines  
M +63 (0) 918 903 4928  
E [hello@ohmm.ph](mailto:hello@ohmm.ph)

### GENERAL

#### COLOUR

Minor variations may occur with fibre and fabric by virtue of production runs and natural variations.

#### DIMENSIONS

As all our products are handmade, variations are possible with regard to dimensions. The published dimensions are rounded up to the nearest cm.

### LEGAL

#### REGISTERED COPYRIGHT & DESIGN

All OHMM® products, collections, photos, images, trademarks, logos, labels and special features are designed by our designers and OHMM® Design Studio. They are protected by international copyright and intellectual property laws. All our products carry the OHMM® badge or label and are protected by trademark law.

Any use or infringement of copyright or intellectual property is strictly prohibited and any infringements will

be vigorously pursued, as well as the right to claim damages.

© 2023 OHMM® Pte Ltd, Singapore. All rights reserved. No part of this catalogue may be reproduced or transmitted by any means, electronic or mechanical, including photocopy or any storage or retrieval system, without consent by OHMM®.

Respect Copyright. Encourage Creativity!

### THANK YOU

A sincere thank you to all our clients who have entrusted us with their custom. We wouldn't be here without your support.

And to the OHMM® Team for all their energy, dedication and loyalty that keeps us moving ever forward.

Kevin Boland | Founder

# NOT CONVINCED? MORE REASONS TO CHOOSE OHMM

## WORLD CLASS QUALITY

We own our manufacturing facility where we meticulously manage and quality control every step of the production process. This means you are buying a product that is lovingly handcrafted in-house with care and pride. We only use premium materials. Combine this with the world's best woven furniture craftsmen in the Philippines and we believe you have a product that is simply world class.

## DESIGN & CUSTOMISATION

We have a simple philosophy - that great design gives us pleasure and improves the quality of our lives through products that work well, are affordable and look beautiful. Furthermore, we offer an unprecedented choice of fibre and fabric options - so you have the freedom to customise your OHMM® furniture as you want it.

## DURABILITY & LOW MAINTENANCE

Outdoor furniture has to withstand some very rough treatment and our quality of build is second to none. And OHMM® woven products are low maintenance and easy to clean which all adds up to giving you many years of carefree performance.

## SUSTAINABILITY & NO FALSE ECONOMY

We recycle all we can and our products are toxin free, but we firmly believe the biggest sustainability factor is that OHMM® products will last years with proper care. Investing a little more in quality products simply makes good sense - so you save money in the long run.

## WARRANTY

We stand behind our products with a 5 Year Residential Warranty and a 3 Year Project Warranty. So that's peace of mind for you. See our website for full details.

## TRACK RECORD

Prestigious establishments and private individuals have selected OHMM® products around the world for over 15 years. It's very rewarding that many of our orders come from repeat clients. There is no leap of faith with OHMM®.

Need we say more? Contact us today.





[WWW.OHMM.GLOBAL](http://WWW.OHMM.GLOBAL)